

Part II (Processes): Basics of fusion welding processes



II.1. Gas welding



Aim & Objectives

Module Aim:	The knowledge necessary for performance of the basic tasks of the professional activity of a gas welder
Number of hours:	E-learning → 2h and self-study → 2h
Learning outcomes: COMPETENCES	<ul style="list-style-type: none">• Operating rules of gas welding equipment• Measuring and regulation of pressure• Types of flames and their usage• Flame regulation• welding technique of seams (manipulation)• Work protection
ECVET:	<i>60 ECVET points are allocated to the learning outcomes expected to be achieved in a year of formal full time VET</i>

Learning outcomes

Learning outcomes: SKILLS

- To prepare the gas welding machine for work and to assess the technical condition of the welding equipment.
- To set the gas pressures according to the task to be performed
- To select the heads of welding torches and regulate the flame
- Ability to select the sequencing of seam welding
- To carry out the work by not harming the health of your own or other persons
- To use the professional terminology in the official language and in one foreign language

Learning outcomes

Learning outcomes: KNOWLEDGES

- To prepare the gas welding machine for work and to assess the technical condition of the welding equipment.
- To set the gas pressures according to the task to be performed.
- To select the heads of welding torches and regulate the flame.
- Ability to select the necessary consumable materials for welding
- To select and use personal protective equipment and collective working protective equipment according to the work task
- To observe the standards of the legal employment relationship

Lecture Outline

- Gas welding principles
- Gas welding equipment, torch and blowpipe
- Flame ignition and shutting off the torch
- Flame types and properties
- Gas cylinders, pressure regulators, hoses, safety accessories
- Properties of acetylene and oxygene
- Welding consumable: the rod
- Welding technics and malfunctions
- Applications and standards

Gas welding principles

The metals are melted by the heat of a flame, and the weld will be formed by the solidification of the weld pool.

The weld metal can contain:

- a) Only the base materials → this case: autogeneous welding
- b) The base materials + the filler material, named as rod

The gas welding is a fusion welding process in which the parent materials have to be melted by using a heat source of the flame of a **combustible gas** and a **comburent gas**.

Gases are: **acetylene (C₂H₂)**, propane, propane-butane mixture, fuel gas, hydrogen, **oxygen**, air.

US term for gas welding is: oxyfuel gas welding.

Gas welding principles – the joint

Base material: the material to be welded, brazed, soldered or cut, and any material to which a thermal sprayed coating or surfacing weld is applied.

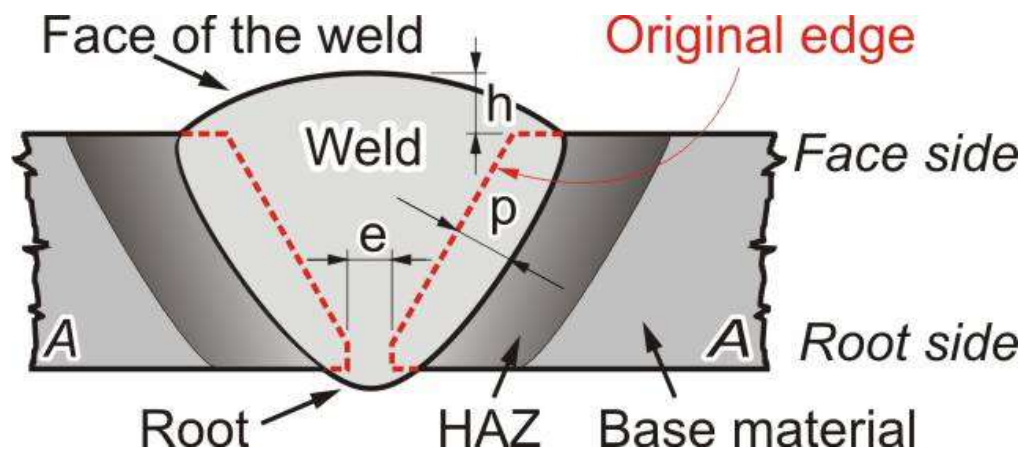

Weld: a localized coalescence of materials produced either by heating the materials to suitable temperatures, with or without the application of pressure, or by the application of pressure alone, and with or without the use of filler material.

Gas welding principles

- **Weld bead:** a weld deposit resulting from a pass.
- **Weldment:** an assembly whose component parts are joined by welding.

- **Fusion zone.** The area of base metal melted as determined on the cross section of a weld.

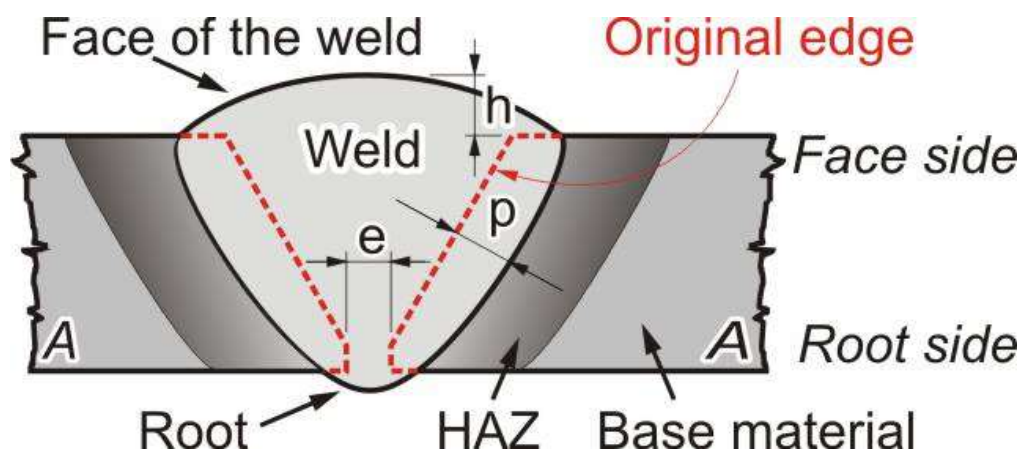

- **Heat affected zone (HAZ):** that part of the base metal which has not been melted, but whose mechanical properties or microstructure have been already altered by the heat of welding, brazing, soldering, or cutting.

Gas welding principles

Weld pool is the liquid state of a weld prior to solidification as weld metal. When filler metal is applied, the weld metal chemical composition is determined by the composition of the base metal, the filler metal and by the dilution ratio (δ). The dilution ratio is the ratio of the amount of the base metal melted to the total amount of the weld metal.

The dilution ratio is 100 % for welding without filler metal.

When welding
 a root pass, $\delta = 30 \%$;
 a fill pass, $\delta = 5-15 \%$;
 a cover pass, $\delta = 5-10 \%$

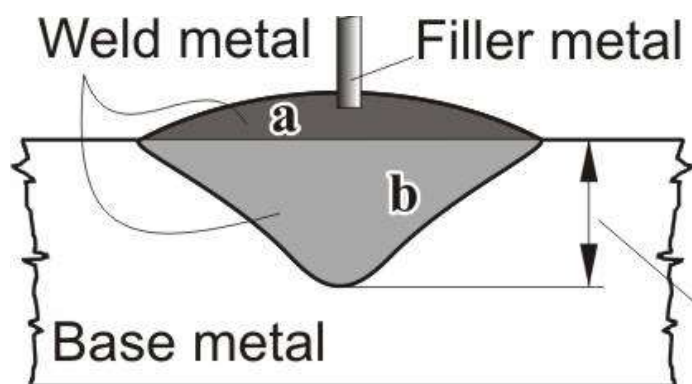

Dilution ratio

$$\delta = \frac{b}{a + b}$$

Fusion depth

Gas welding station

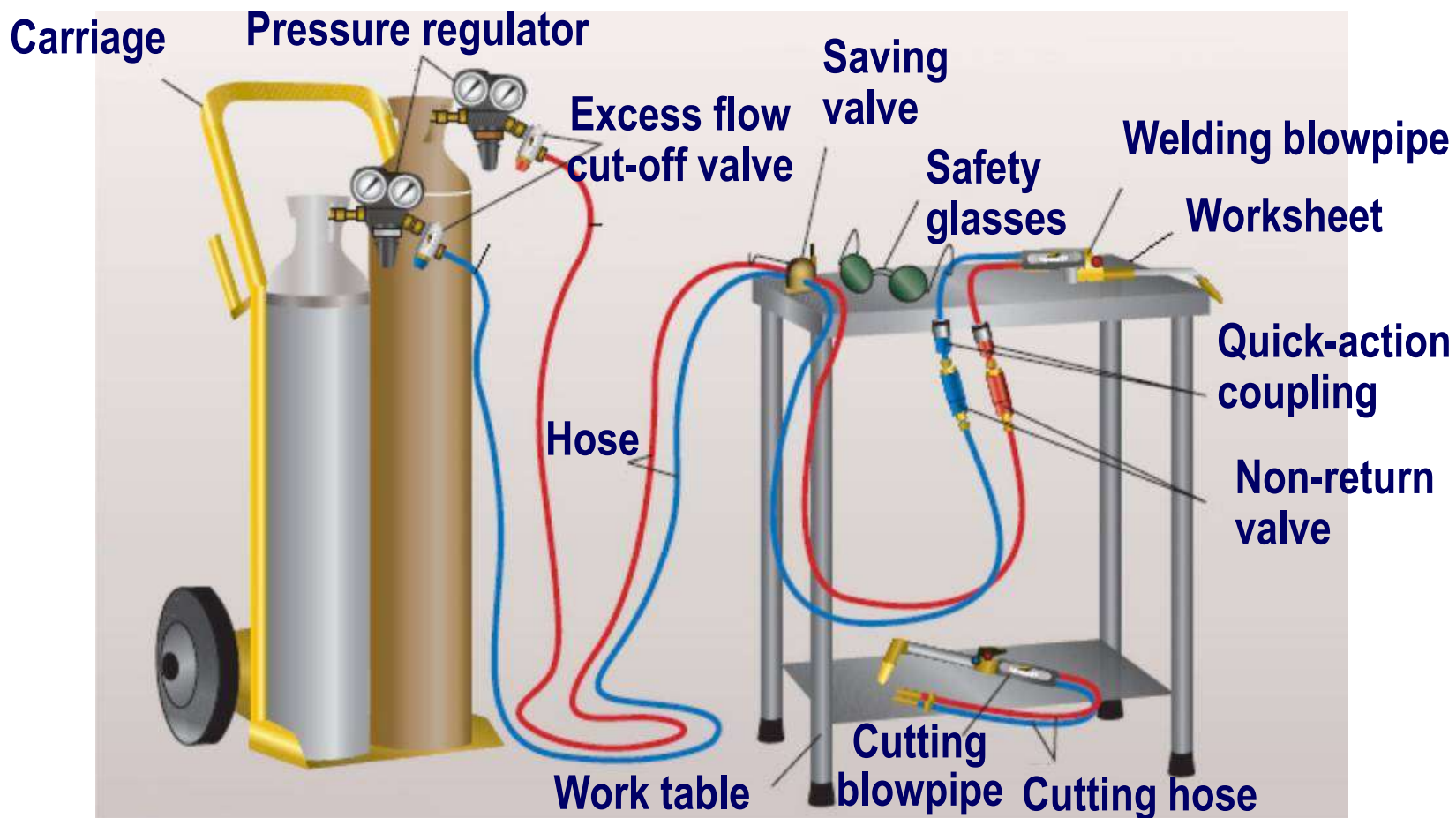

Gas welding equipment

The parts of the gas welding equipment are

- the hoses,
- hose assemblies,
- blowpipes and nozzles
- safety devices.

The gas welding equipment must meet statutory safety and health requirements.

The welding torch

Parts of a gas welding torch

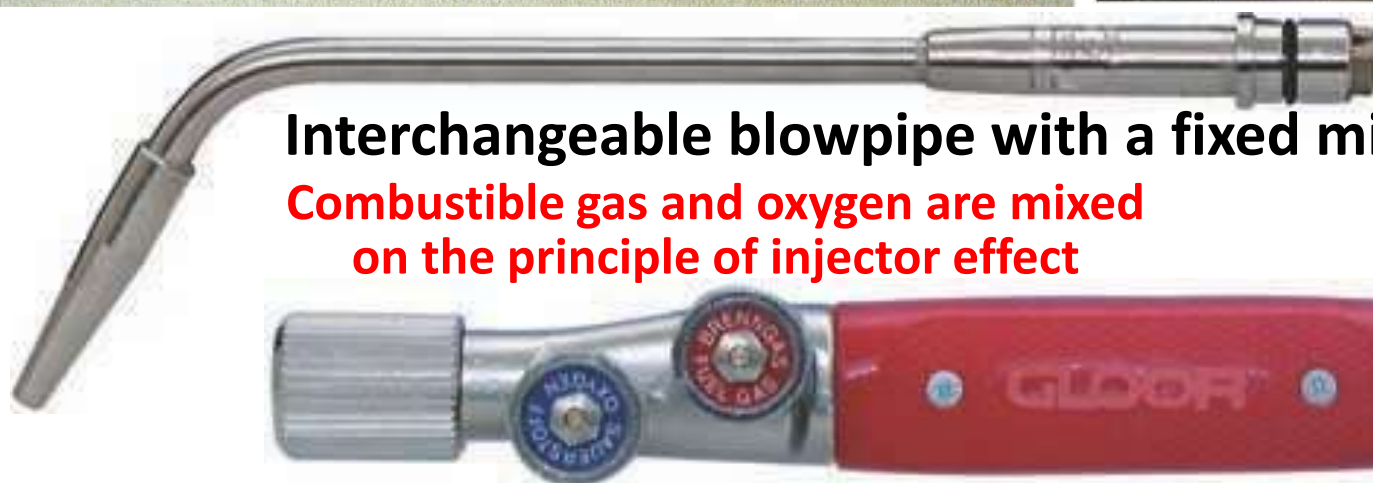
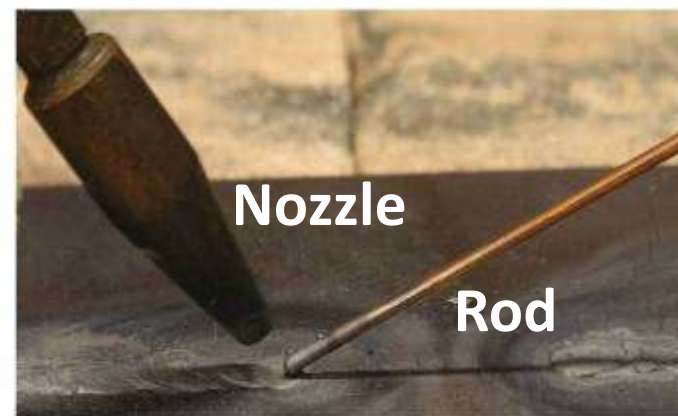

The torch

Interchangeable shaft and blowpipe

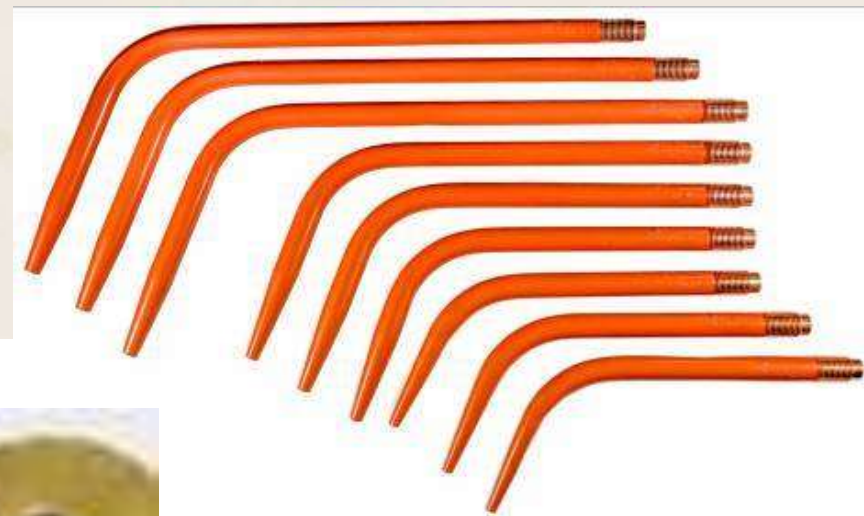

Nozzle shapes

for propane

for acetylene



Flame ignition – lighting the torch

1. Check that the oxygen and acetylene torch valves are closed.
2. Check that the regulator adjusting screws are turned counterclockwise and move freely. Do not turn the adjustment screws too far, or they will come off.
3. **Warning do not stand directly in front of the regulator when opening the cylinder valve. The high pressure gas could burst the regulator and cause injury.**
4. Slowly open the acetylene valve, so you can quickly shut off the gas in an emergency.
5. Slowly open the oxygen valve as far as it will go, so oxygen cannot leak around the valve stem.

Flame ignition – lighting the torch

6. Set the correct working pressure on the acetylene regulator gauge.
7. Do this by opening the acetylene torch valve and turning the acetylene regulator adjusting screw unit the desired pressure is reached.
8. Close the acetylene torch valve.
9. Repeat Step 5 to set the oxygen working pressure.
10. Open the acetylene torch valve $\frac{1}{2}$ turn.
11. Using a standard friction (spark) lighter, light the acetylene gas.

Flame ignition – lighting the torch

12. Always use a friction lighter to light the torch. Never use matches or butane lighters. Your hand could be severely injured when the gas fumes are ignited.
13. Adjust the flame until it burns turbulently approximately $\frac{3}{4}$ " from the torch tip. Then adjust the flame so no sooty smoke is released.
14. Slowly open the oxygen torch valve.
15. Adjust the oxygen until a small pointed cone appears at the torch tip.
16. This is a neutral flame.
17. Minor adjustments in the torch valves and regulator pressures may be necessary to obtain a neutral flame.

Shutting off the torch

1. Close the acetylene torch valve on the torch body to extinguish the flame.
2. Then, close the oxygen torch valve so gas is not being released from the torch tip.
3. Close both the acetylene and oxygen cylinder valves.
4. Open both torch valves on the torch body to release any gas still in the lines (bleed the lines).
5. Watch the acetylene and oxygen regulators until you see that the high and low pressure gauges on both regulators read zero.
6. Turn the adjusting screws on both regulators counterclockwise until they turn freely with no tension.

Shutting off the torch

7. Once the gauges read zero, the adjusting screws are loose, and the torch valves are closed, roll up the hoses, and put the torch away.

Flame ignition – lighting the torch

Tools for lighting the flame



Flame types



Welding of cast irons



Welding of carbon steels and low alloy steels

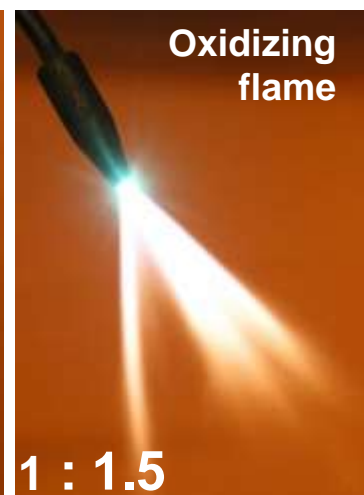

Welding of brass

Flame properties

Temperature distribution in oxy-acetylene flame

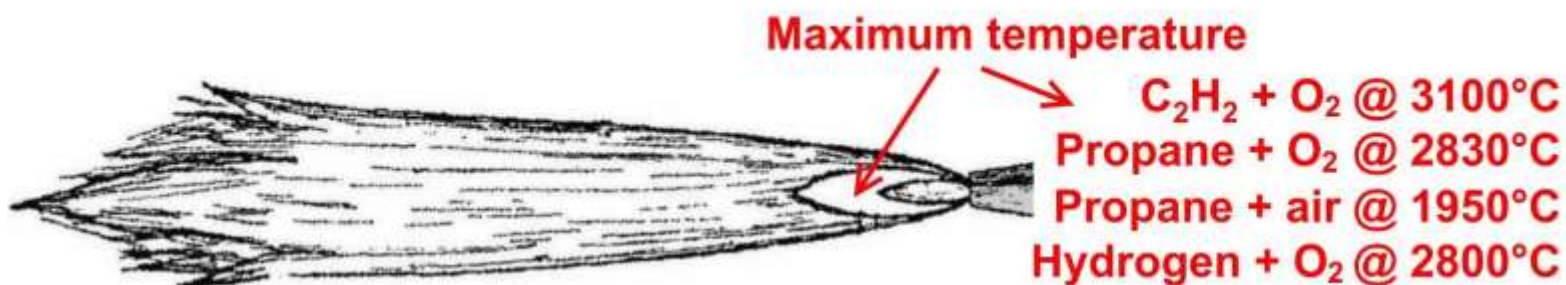
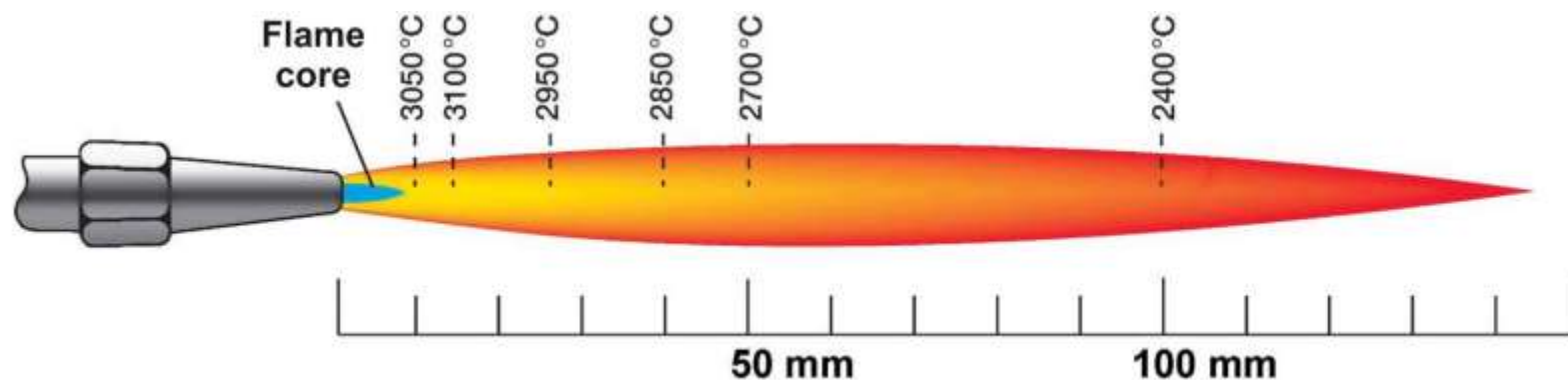

Gas cylinders – neck colours



**O₂ = white # C₂H₂ maroon
cylinder**



Valve
**Porous materials:
Ca-hydrosilicates
(in old bottles:
asbestos + cement +
diatomaceous earth)**

The standard EN 1089-3

EN 1089-3:2011 Transportable gas cylinders.
Gas cylinder identification. Colour coding



The neck colour

Oxygen = white

Acetylen = maroon

Colour coding of the cylinder

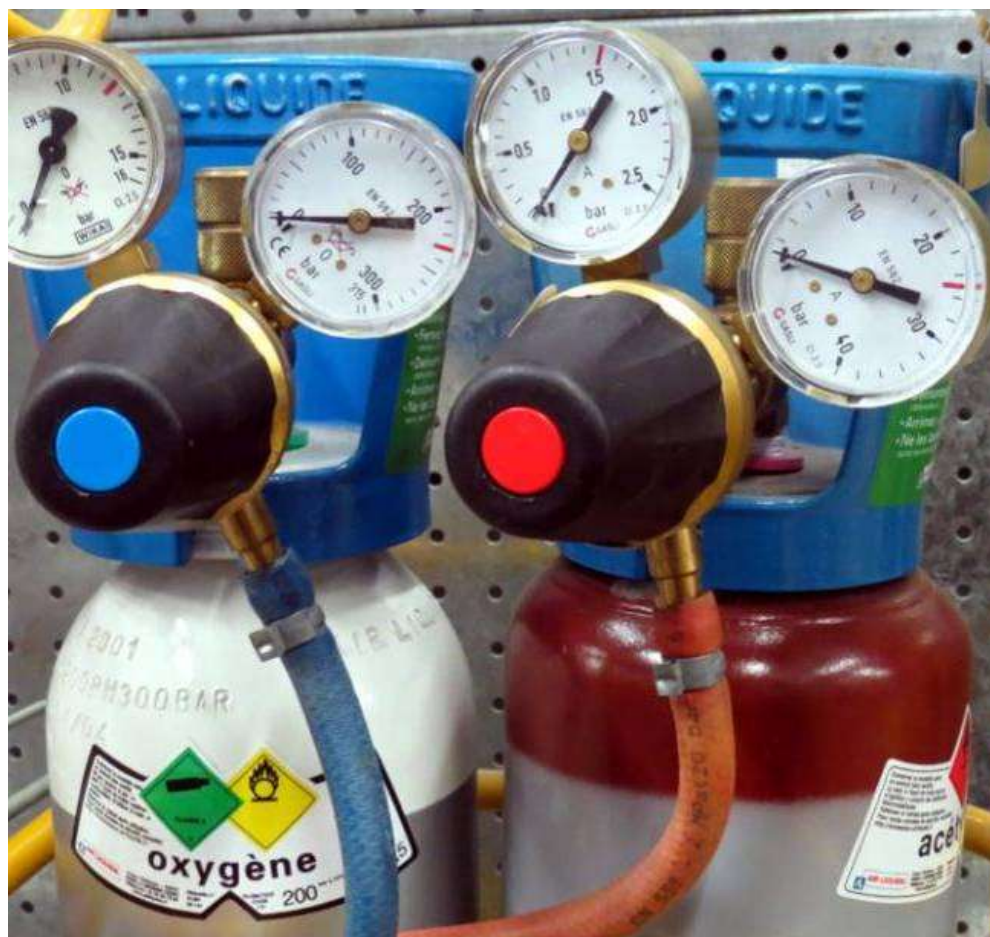

Pressure regulator

Pressure regulator for acetylene: stirrup bracket (left) or flared joint (right).



Pressure regulator for oxygen: flared joint.

Pressure regulator for acetylene



Pressure regulator for acetylene cylinder with stirrup bracket

**Cylinder pressure: < 16 bar
Throttle down pressure: 0.3–0.8 bar
needed for welding**



Certification of pressure regulator



The pressure gages of the pressure regulators shall be verified by a regular inspection



Pressure regulator for oxygen

Cylinder pressure: < 200 bar
Throttle down pressure: 1.0–5.0 bar



**Pressure regulator for
oxygen cylinder with
flared joint**



Excess flow cut-off valve



The excess flow cut-off valve automatically cuts off the gasflow, if the hose is disconnected, pierced or the connector is not properly tightened despite the open throttle valve.

Accessories – the hoses

Standardized colours

Colour	Ø (mm)	Gas
Blue	6.3 and 10	Oxygen
Red	6.3 and 10	Acetylene
Orange	6.3 és 10	Propane
Black	6.3	Other

**Hoses
mounted
with
hose-end
connectors**



Safety: flashback arrestor

Simple: contains a flashback valve, a fine filter at the gas inlet, thermofusible element and a flame retardants (so called syringe cylinder).

Enhanced Safety: A device with a protective cover for damage from falling and a pressure gauge flashback valve.

Mounted on a welding torch: stainless steel flame retarder, non-return valve and filter.

Resettable flame retardant inhibitors: Includes a pressure switch and a visible indicator arm. It is advisable in difficult industrial conditions.

Flashback arrestor



Flashback arrestor



Flashback arrestor



2016-1-RO01-KA202-024508

The content of the present material is the sole responsibility of the authors, and the National Agency and European Commission cannot be held responsible for any use which may be made of the information contained therein.



Co-funded by the
Erasmus+ Programme
of the European Union

The comburent gas: oxygen

**Oil or grease + oxygen:
Flammable without any heat or pressure.
Flame → Explosion**

Colour on the **cylinder neck**: white (RAL 9010); on the cylinder: blue (RAL 5010)

Conversions

1 m³ of liquid oxygen at the boiling point corresponds to 854 m³ of 15 °C oxygen pressure of 1 bar.

1 kg of oxygen corresponds to 0.7479 m³ of oxygen at a pressure of 15 °C (1 bar).

1 kg of oxygen corresponds to 876.4 litres of liquid oxygen at atmospheric pressure (-182.97 °C).

1 m³ of 15 °C oxygen pressure of 1 bar corresponds to 0,9355 m³ of normal oxygen (0 °C, 1,01325 bar) oxygen.

Oxygen

Forms of transport
(quantity and pressure)

1,5 m³ → 150 bar

2 m³ → 200 bar

10 m³ → 200 bar

10 m³ → 300 bar



Purity of the gas: Tanker

2.5 / 3.5 / 4.5 / 5.0

2.5 = 99,5%

4.5 = 99,995%



Labels on the cylinder

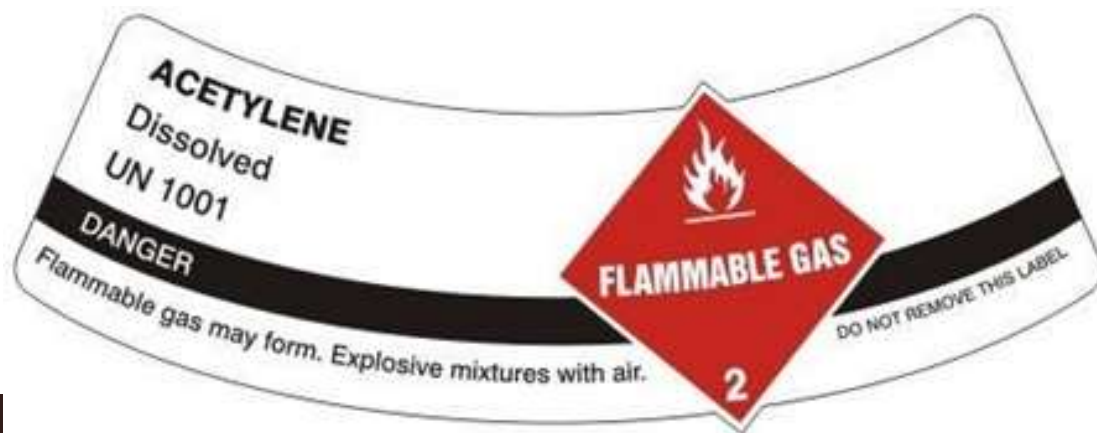

Combustible gas properties

* Compared to air

**For a neutral flame

Gas	Sign	Density*	Flame temperature, °C**	Combustion heat, MJ/m ³ (Flamezone)		
				I. zone	II. zone	Σ
Acetylene	C ₂ H ₂	0,906	3100	19	36	55
Propane	C ₃ H ₈	1,55	2530	10	94	104
Butane	C ₄ H ₁₀	2,08	2930	21	70	91
Propylene	C ₃ H ₆	1,48	2900	16	73	89
Methan	CH ₄	0,62	2540	0,4	37	37
Hydrogen	H ₂	0,07	2660	-	-	12

Acetylene: as a important combustible

- Explosive: above 2.3% mixing rate.
- It has a sufficiently high heat output and combustion heat.
- It can also be used for welding, cutting, preheating, post-heat treatment and flame retardation.
- Sometimes excessive heat dissipation especially when cutting and preheating.
- Small self-ignition temperature: 305°C.
- **Actual** application area for welding: only for non-alloyed and low-alloy steels.
- **Jeweler's work on non-ferrous and light metals is not acetylated, but is propaned or hydrogened.**
- **Welding of other materials is now an exceptional event.**

The acetylene

Conversions between liquid and gas phase

- **1 m³ of liquid** acetylene at the triple point corresponds to **556 m³ of acetylene gas** at 15 °C with a pressure of 1 bar.
- **1 kg** of acetylene corresponds to **0.913 m³** of acetylene **gas** at 15 °C with a pressure of 1 bar.
- **1 m³** of acetylene at 15 °C with a pressure of 1 bar corresponds to **0.932 m³** of normal acetylene (0 °C, 1.01325 bar).

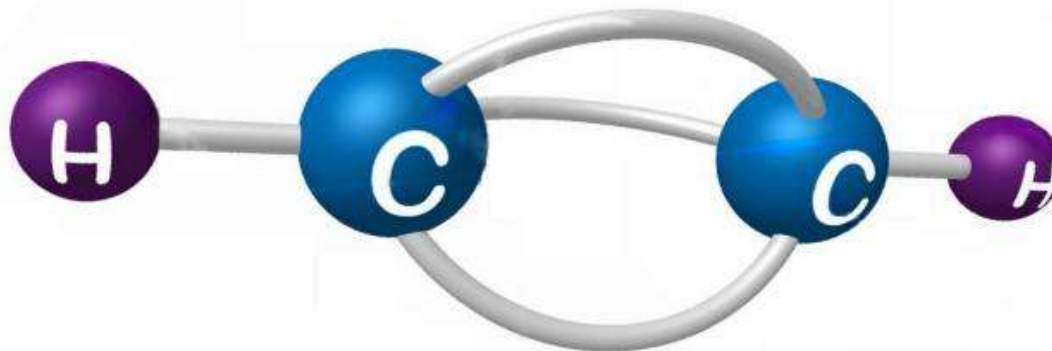

The acetylene

Acetylene is done as a gas dissolved in liquid acetone. The acetone is filled into a porous material. Acetylene molecules are separated from one another by acetone molecules, and the porous mass eliminates the critical free volumes so that the decomposition chain reaction can be safely inhibited. The old mass (a mixture of charcoal, asbestos, cement and diatomaceous earth) has a porosity of about 75% and an average of 92% for the new types of Ca-silicate homogeneous masses. In cylinders containing new types of masses, it is possible to store more acetylene, but due to the smaller pore sizes, the maximum gassing speed is lower. In the case of a higher take-off speed, liquid acetone is removed from the bottle and the acetylene gas is saturated with acetone.

The acetylene

Instead of acetone, dimethylformamide is used in the bundles of bottles as a solvent with substantially less vapor pressure than acetone. The saturation gas concentration is also smaller, leaving fewer vapors leaving the acetylene and, as a result, does not have to be replaced so often.

The purity of the acetylene leaving the cylinder increases during use as the main contaminant, nitrogen, is reduced due to poor solubility in relation to the initial value.

Connection of cylinder valve: DIN 477 Nr. 3: stirrup bracket.

The acetylene cylinder

The old, so-called type D3 bottle contains charcoal that has its own porous structure with a ca. 75% porosity. Manufacturing new, modern masses, a mixture of silica and calcium hydroxide in the bottle is reacted for approx. at 12 bar vapor pressure and 180 °C. At this time crystalline water containing calcium silicate is formed, from which the water drains out micropores and capillaries. Such homogeneous bottle masses have a pore volume of at least 92%.

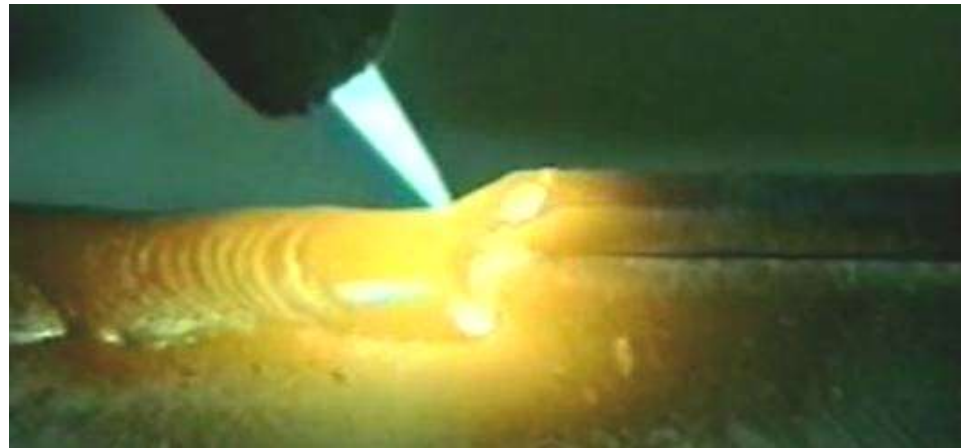

The acetylene cylinder

Component		Charcoal (old type D3)	Ca silicate (new type)	
		Volume %		
Volume of solid mass		25,0		8,0
Porosity	Original volume of acetone	75,0	37,1	39,0
	Acetone volume increase after acetylene loading		27,9	40,0
	Safety volume		10,0	13,0
Volume of empty cylinder		100,0		100,0

Most used cylinders

Acetylene

Colour: **maroon**

Connection: stirrup bracket

Cylinder volume: 40 L

Acetone volume: 13 L

Pressure: 19 bar

Acetylene volume: 6000 L

Gassing speed: up to 700 L/h



Oxygen

Colour: **white**

Connection: flared joint

Cylinder volume: 50 L

Oxygen volume: 10 000 L

Pressure: 200 bar



Gas welding processes

- **EN ISO 4063:2011 Welding and allied processes - Nomenclature of processes and reference numbers**

3	Gas welding Oxyfuel gas welding (USA)
31	Oxyfuel gas welding
311	Oxyacetylene welding
312	Oxypropane welding
313	Oxyhydrogene welding

Technological variables

- $d_h = 1-10$ mm
nozzle diameter)
- $p_{C_2H_2} = 0,1-0,6$ bar
- $p_{O_2} = 2-5$ bar
- $v_{heg} = 10-100$ mm/min
- $V_{C_2H_2} = 1-50$ L/min
- $V_{O_2} = 1-55$ L/min

Welding consumable: rod

EN 12536:2000 Welding consumables. Rods for gas welding of non alloy and creep-resisting steels. Classification

In EN 12536:2000 the types : O I – O II – O III – O IV – O V – O VI

C: 0.08 (0.03-0.12)

O III → Ni = 0.35-0.80%

Diameter: 1.0–6.0 mm

Si: 0.10 (0.02-0.20)

IV → 0.55% Mo

Mn: 0.50 (0.35-0.65)

V → 0.55% Mo + 1% Cr

S < 0.025; P < 0.03

VI → 1.05% Mo + 2.1% Cr

EN 12536 : 2000 = OI
AWS 5-2 = R45
DIN 8554 = G1

Behavior of the rod during welding:

	I	II	III	IV	V	VI
Viscosity	High	Slight	Viscous	Viscous	Viscous	Viscous
Spattering	High	Slight	No	No	No	No
Porosity	Yes	Yes	No	No	No	No

The rods are generally copper-coated. Their length is 1 m.

Choosing the rod diameter

If the rod is too thin: overheating, spattering.

If the rod is too thick: hard to melt, the weld pool will be colled down, sticks.

In case of leftward welding: $d = s/2 + 1$ (mm)

d = diameter of rod (mm), s = plate thickness (mm)

In case of rightward welding: $d = s$



Characteristics of blowpipes

Number	Plate thickness (mm)	Flow rate of gas (L/h)
1	0,5–1	80 ± 10
2	1–2	160 ± 15
3	2–4	315 ± 30
4	4–6	500 ± 50
5	6–9	800 ± 80
6	9–14	1250 ± 125
7	14–20	1800 ± 180
8	20–30	2500 ± 250

From the cylinder ~700-800 L/h acetylene can be safely removed.
 In case of greater demand, several cylinder should be used

The technics of gas welding

Leftward welding
for $s < 5$ mm

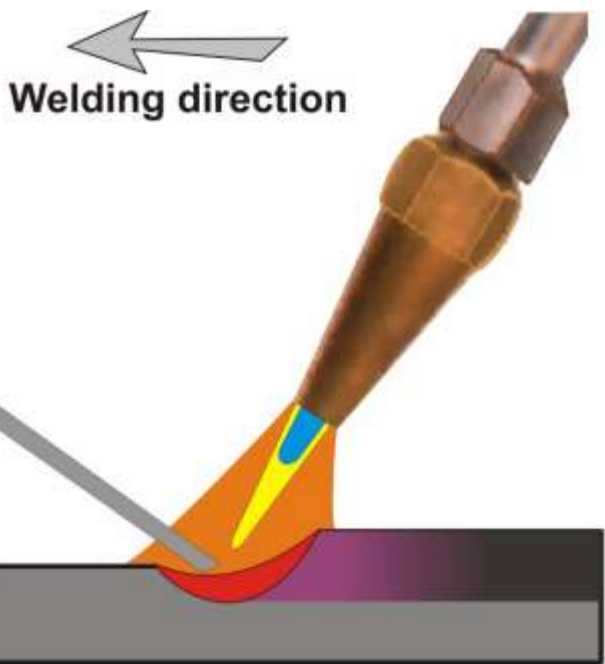

Thin plate

Rightward welding
Deep penetration

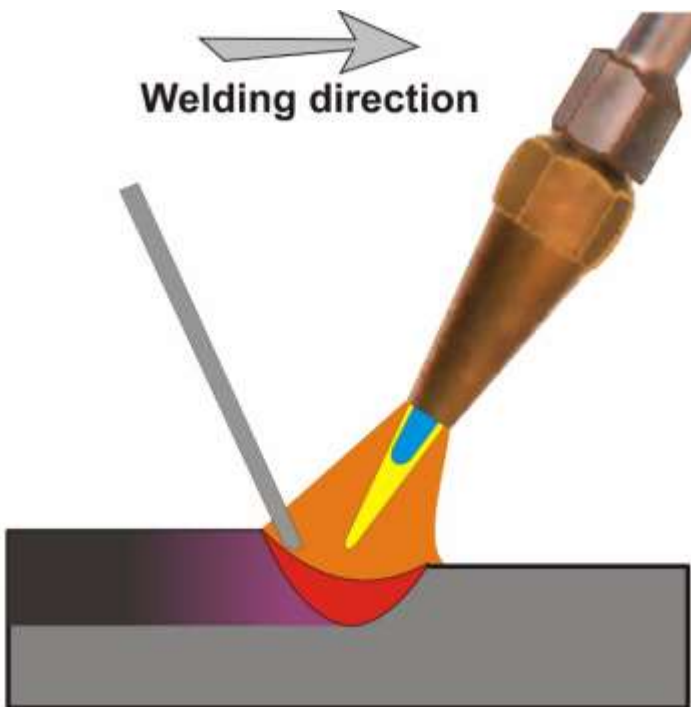

Thick plate

The technique of welding

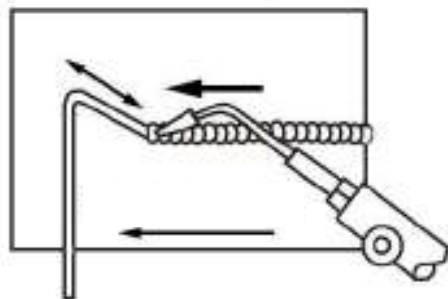

Leftward

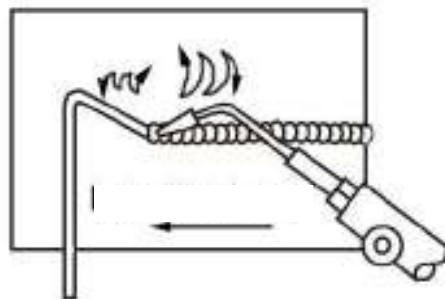

Rightward

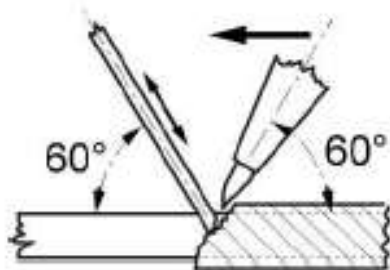
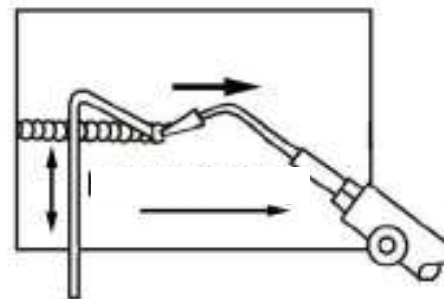

Rod

Dipping

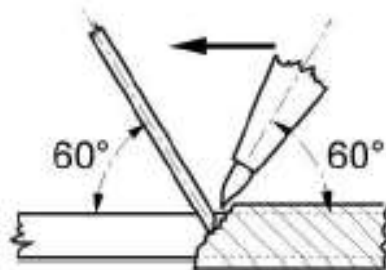

Rod

Weaving

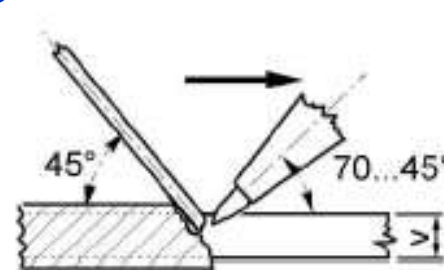

Rod

Weaving-Circling



Malfunctions

Backfire

The return of the flame into the blowpipe with a popping sound, the flame being either extinguished or reignited at the nozzle.

Sustained backfire

The return of the flame into the blowpipe with continued burning within the neck or mixer (this may be accompanied by an initial popping sound followed by a continuous hissing sound from the continued burning within the blowpipe).

Backflow

Flowing back of the gas at the higher pressure into the hose of the gas at the lower pressure. This can be caused by the nozzle exit becoming blocked or restricted

Blowing off the flame

The detachment of the flame from the blowpipe nozzle. This may cause the flame to be extinguished.

Application of gas welding

- Thin plates, pipes
- Repair welding
- Building engineering, heating systems, plumbing, gas pipelines
- Other procedures are not or are very difficult to apply
- Sketches of airplanes (!) sports airplanes
- Bicycle
- Jewelry

Special application of gas welding



AviPro Aircraft Ltd. **In the vicinity of the flame-welded joint, the strength change is much more even than the arc-welded joint.**

Source: www.airbus.com/pireps/AviproPlant.html

Special application of gas welding



Car body repair

Special application of gas welding



Building installation piping

Special application of gas welding

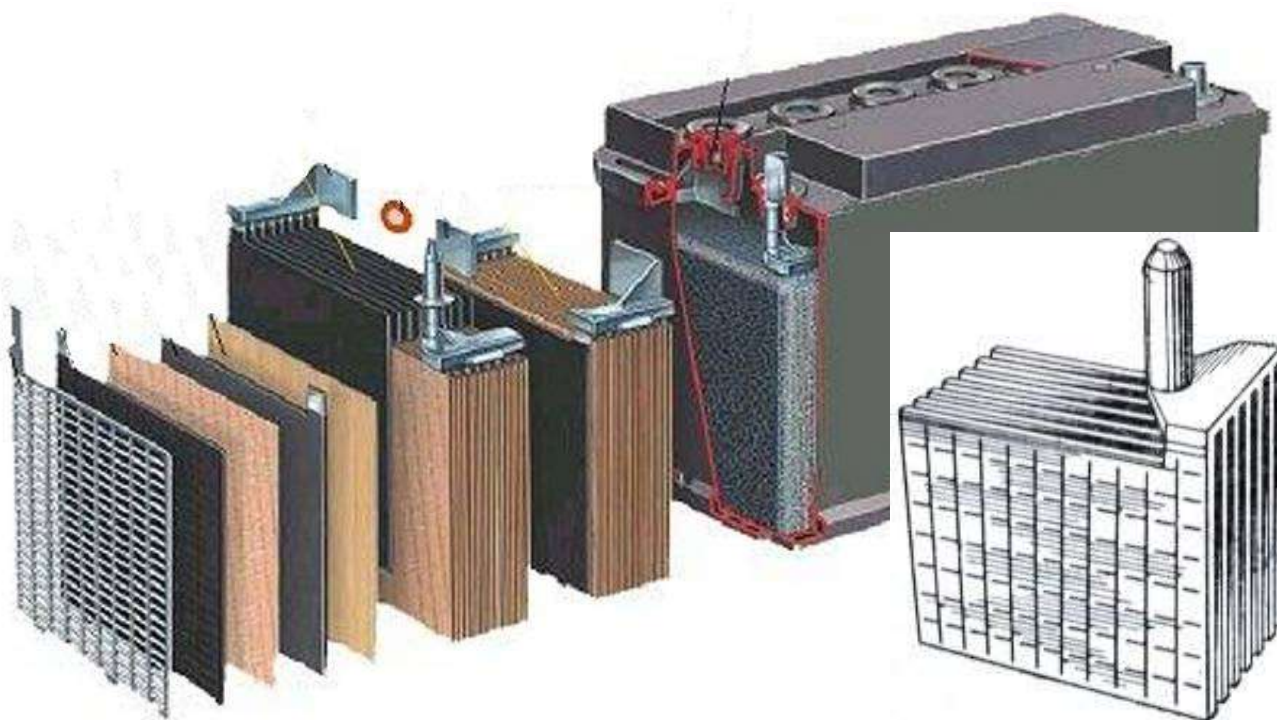

In lead-acid starter batteries, welding of cell connectors and pole guides. Automated gas welding process.

Oxyhydrogen gas welding

The nozzle is often an injection needle.

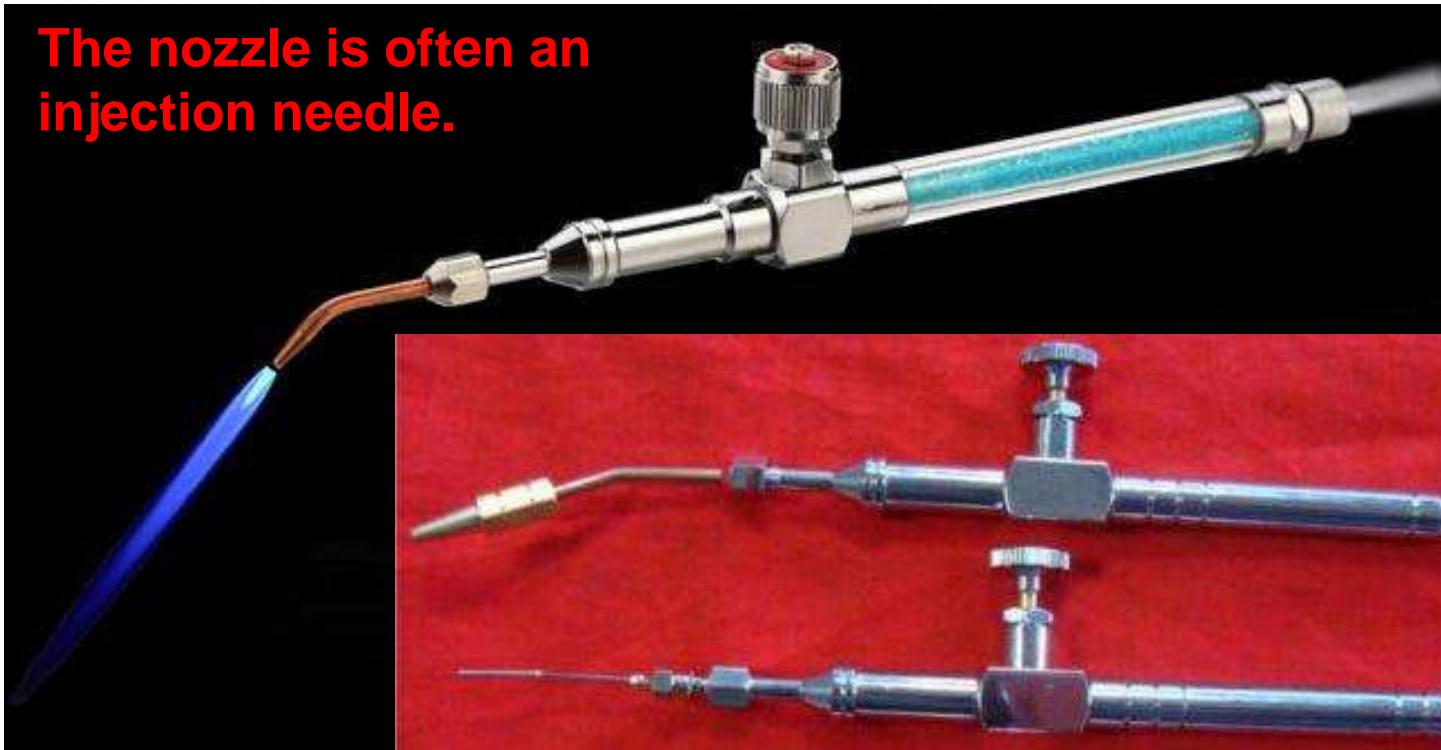

Gold, silver, platinum, enameled wires, brass instruments, thermocouple wires, anchors hooks, electromotors, exhausts, air conditioners, medical (micro-) welding.

Special application of gas welding



51 European standards for gas welding are available

- [EN 379:2003+A1:2009](#) (WI=00085079) >< Personal eye-protection - Automatic welding filters
- [EN 560:2005](#) (WI=00121373) >< Gas welding equipment - Hose connections for equipment for welding, cutting and allied processes
- [EN 560:2005/AC:2007](#) (WI=00121C16) >< Gas welding equipment - Hose connections for equipment for welding, cutting and allied processes
- [EN 561:2002](#) (WI=00121374) >< Gas welding equipment - Quick-action coupling with shut-off valves for welding, cutting and allied processes
- [EN 730-1:2002](#) (WI=00121335) >< Gas welding equipment - Safety devices - Part 1: Incorporating a flame (flashback) arrestor
- [EN 730-2:2002](#) (WI=00121336) >< Gas welding equipment - Safety devices - Part 2: Not incorporating a flame (flashback) arrestor
- [EN 1256:2006](#) (WI=00121376) >< Gas welding equipment - Specification for hose assemblies for equipment for welding, cutting and allied processes
- [EN 1326:1996](#) (WI=00121107) >< Gas welding equipment - Small kits for gas brazing and welding
- [EN 1327:1996](#) (WI=00121124) >< Gas welding equipment - Thermoplastic hoses for welding and allied processes

51 European standards for gas welding are available

[EN 1708-2:2000](#) (WI=00121199) >< Welding - Basic weld joint details in steel - Part 2: Non internal pressurized components

[EN 10312:2002](#) (WI=EC110108) >< Welded stainless steel tubes for the conveyance of aqueous liquids including water for human consumption - Technical delivery conditions

[EN 12536:2000](#) (WI=00121217) >< Welding consumables - Rods for gas welding of non alloy and creep-resisting steels - Classification

[EN 12814-5:2000](#) (WI=00249325) >< Testing of welded joints of thermoplastics semi-finished products - Part 5: Macroscopic examination

[EN 13067:2012](#) (WI=00249767) >< Plastics welding personnel - Qualification testing of welders - Thermoplastics welded assemblies

[EN 13622:2002](#) (WI=00121312) >< Gas welding equipment - Terminology - Terms used for gas welding equipment

[EN 13705:2004](#) (WI=00249337) >< Welding of thermoplastics - Machines and equipment for hot gas welding (including extrusion welding)

[EN 14728:2005](#) (WI=00249491) >< Imperfections in thermoplastic welds - Classification

European and international standards

[EN 16296:2012](#) (WI=00249768) >< Imperfections in thermoplastics welded joints - Quality levels

[EN 29090:1992](#) (WI=00121062) >< Gas tightness of equipment for gas welding and allied processes (ISO 9090:1989)

[EN ISO 636:2017](#) (WI=00121761) >< Welding consumables - Rods, wires and deposits for tungsten inert gas welding of non-alloy and fine-grain steels - Classification (ISO 636:2017)

[EN ISO 1071:2015](#) (WI=00121664) >< Welding consumables - Covered electrodes, wires, rods and tubular cored electrodes for fusion welding of cast iron - Classification (ISO 1071:2015)

[EN ISO 2503:2009](#) (WI=00121520) >< Gas welding equipment - Pressure regulators and pressure regulators with flow-metering devices for gas cylinders used in welding, cutting and allied processes up to 300 bar (30 MPa) (ISO 2503:2009)

[EN ISO 2503:2009/A1:2015](#) (WI=00121622) >< Gas welding equipment - Pressure regulators and pressure regulators with flow-metering devices for gas cylinders used in welding, cutting and allied processes up to 300 bar (30 MPa) (ISO 2503:2009/Amd 1:2015)

European and international standards

[EN ISO 3821:2010](#) (WI=00121575) >< Gas welding equipment - Rubber hoses for welding, cutting and allied processes (ISO 3821:2008)

[EN ISO 5171:2010](#) (WI=00121576) >< Gas welding equipment - Pressure gauges used in welding, cutting and allied processes (ISO 5171:2009)

[EN ISO 5172:2006](#) (WI=00121398) >< Gas welding equipment - Blowpipes for gas welding, heating and cutting - Specifications and tests (ISO 5172:2006)

[EN ISO 5172:2006/A1:2012](#) (WI=00121570) >< Gas welding equipment - Blowpipes for gas welding, heating and cutting - Specifications and tests - Amendment 1 (ISO 5172:2006/Amd 1:2012)

[EN ISO 5172:2006/A2:2015](#) (WI=00121623) >< Gas welding equipment - Blowpipes for gas welding, heating and cutting - Specifications and tests (ISO 5172:2006/Amd 2:2015)

[EN ISO 5817:2014](#) (WI=00121579) >< Welding - Fusion-welded joints in steel, nickel, titanium and their alloys (beam welding excluded) - Quality levels for imperfections (ISO 5817:2014)

[EN ISO 7291:2010](#) (WI=00121521) >< Gas welding equipment - Pressure regulators for manifold systems used in welding, cutting and allied processes up to 30 MPa (300 bar) (ISO 7291:2010)

European and international standards

[EN ISO 7291:2010/A1:2015](#) (WI=00121624) >< Gas welding equipment - Pressure regulators for manifold systems used in welding, cutting and allied processes up to 30 MPa (300 bar) (ISO 7291:2010/AMD 1:2015)

[EN ISO 9012:2011](#) (WI=00121605) >< Gas welding equipment - Air-aspirated hand blowpipes - Specifications and tests (ISO 9012:2008)

[EN ISO 9539:2010](#) (WI=00121519) >< Gas welding equipment - Materials for equipment used in gas welding, cutting and allied processes (ISO 9539:2010)

[EN ISO 9539:2010/A1:2013](#) (WI=00121629) >< Gas welding equipment - Materials for equipment used in gas welding, cutting and allied processes (ISO 9539:2010/AMD 1:2013)

[EN ISO 9692-1:2013](#) (WI=00121651) >< Welding and allied processes - Types of joint preparation - Part 1: Manual metal arc welding, gas-shielded metal arc welding, gas welding, TIG welding and beam welding of steels (ISO 9692-1:2013)

[EN ISO 9692-3:2016](#) (WI=00121652) >< Welding and allied processes - Types of joint preparation - Part 3: Metal inert gas welding and tungsten inert gas welding of aluminium and its alloys (ISO 9692-3:2016)

European and international standards

[EN ISO 10042:2005](#) (WI=00121342) >< Welding - Arc-welded joints in aluminium and its alloys - Quality levels for imperfections (ISO 10042:2005)

[EN ISO 10882-2:2000](#) (WI=00121167) >< Health and safety in welding and allied processes - Sampling of airborne particles and gases in the operator's breathing zone - Part 2: Sampling of gases (ISO 10882-2:2000)

[EN ISO 14113:2013](#) (WI=00121659) >< Gas welding equipment - Rubber and plastics hose and hose assemblies for use with industrial gases up to 450 bar (45 MPa) (ISO 14113:2013)

[EN ISO 14114:2014](#) (WI=00121582) >< Gas welding equipment - Acetylene manifold systems for welding, cutting and allied processes - General requirements (ISO 14114:2014)

[EN ISO 15609-2:2001](#) (WI=00121275) >< Specification and qualification of welding procedures for metallic materials - Welding procedure specification - Part 2: Gas welding (ISO 15609-2:2001)

[EN ISO 15609-2:2001/A1:2003](#) (WI=00121431) >< Specification and qualification of welding procedures for metallic materials - Welding procedure specification - Part 2: Gas welding (ISO 15609-2:2003)

European and international standards

[EN ISO 15610:2003](#) (WI=00121279) >< Specification and qualification of welding procedures for metallic materials - Qualification based on tested welding consumables (ISO 15610:2003)

[EN ISO 15613:2004](#) (WI=00121282) >< Specification and qualification of welding procedures for metallic materials - Qualification based on pre-production welding test (ISO 15613:2004)

[EN ISO 15614-1:2017](#) (WI=00121531) >< Specification and qualification of welding procedures for metallic materials - Welding procedure test - Part 1: Arc and gas welding of steels and arc welding of nickel and nickel alloys (ISO 15614-1:2017)

[EN ISO 15614-5:2004](#) (WI=00121285) >< Specification and qualification of welding procedures for metallic materials - Welding procedure test - Part 5: Arc welding of titanium, zirconium and their alloys (ISO 15614-5:2004)

[EN ISO 15614-6:2006](#) (WI=00121286) >< Specification and qualification of welding procedures for metallic materials - Welding procedure test - Part 6: Arc and gas welding of copper and its alloys (ISO 15614-6:2006)

European and international standards

[EN ISO 15615:2013](#) (WI=00121569) >< Gas welding equipment - Acetylene manifold systems for welding, cutting and allied processes - Safety requirements in high-pressure devices (ISO 15615:2013)

[EN ISO 16834:2012](#) (WI=00121599) >< Welding consumables - Wire electrodes, wires, rods and deposits for gas shielded arc welding of high strength steels - Classification (ISO 16834:2012)

[EN ISO 17683:2015](#) (WI=00121702) >< Ships and marine technology - Ceramic weld backing for marine use (ISO 17683:2014)

[EN ISO 21952:2012](#) (WI=00121600) >< Welding consumables - Wire electrodes, wires, rods and deposits for gas shielded arc welding of creep-resisting steels - Classification (ISO 21952:2012)

Useful Topic Related Links



Flashback arrestor

www.youtube.com/watch?v=obcmO4JDNKc

SuperFlash Flashback Demo

www.youtube.com/watch?v=hH1xIWR5f8U

Flame ignition

www.att.bme.hu/~femtech/letoltes/eu-WELD/begyujtas.wmv

Gas welding demo 1

www.youtube.com/watch?v=9gVoigDAeVY

Gas welding demo 2

www.youtube.com/watch?v=VfRQxxxLJuo

Gas welding demo 3

www.youtube.com/watch?v=dVZ1LbQCU3o

Gas welding demo 4

www.youtube.com/watch?v=l6HVJHsOGa0

II.2 Manual Metal Arc Welding

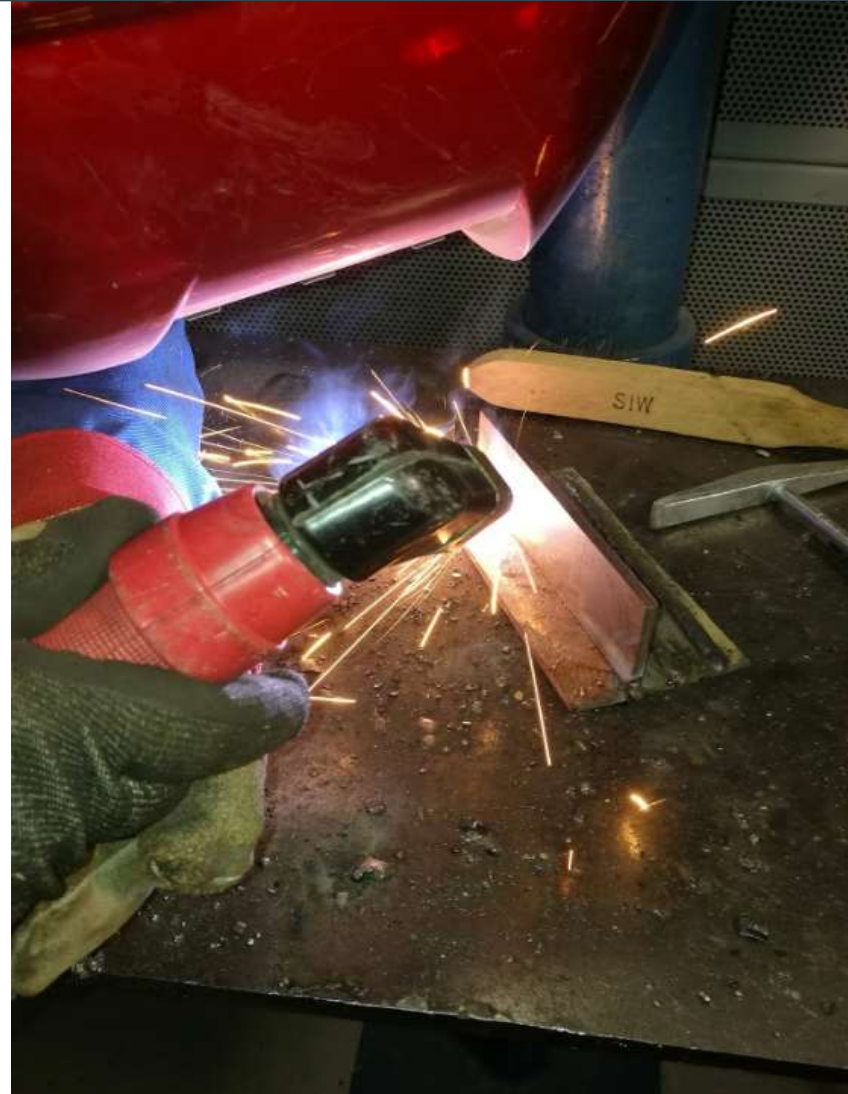

Learning Outcomes

- Knowledge of the MMA welding principles
- Knowledge of to select the appropriate type of current, polarity and electrode according to application.
- Identification of the application range, appropriate joint preparations and how to overcome potential problems

Topics

- General welding aspects
- Specific norms of health & safety
- Control of welding current, instruments to be used and validation of measuring instrument
- Arc starting aids
- Earthing arrangements, cables, electrode holders
- Maintenance of equipment, conditions cables and connections; Cleanliness of contact faces, cleanliness of internal components.
- Covered electrodes (functions of the coating and rod, types of electrodes)
- Typical welding parameters, selection of electrode type and size

General Welding Aspects

- MMA = Manual Metal Arc welding
- Also known as SMAW = Shielded Metal Arc Welding
- MMA welding uses a consumable electrode with a solid wire core and a flux coating
- Filler metal is predominantly supplied by the metal core, but some flux coatings contain metallic powders that melt in the weld pool
- Shielding gas to protect the weld pool is generated by melting of the flux coating.

General Welding Aspects – Basic Equipment

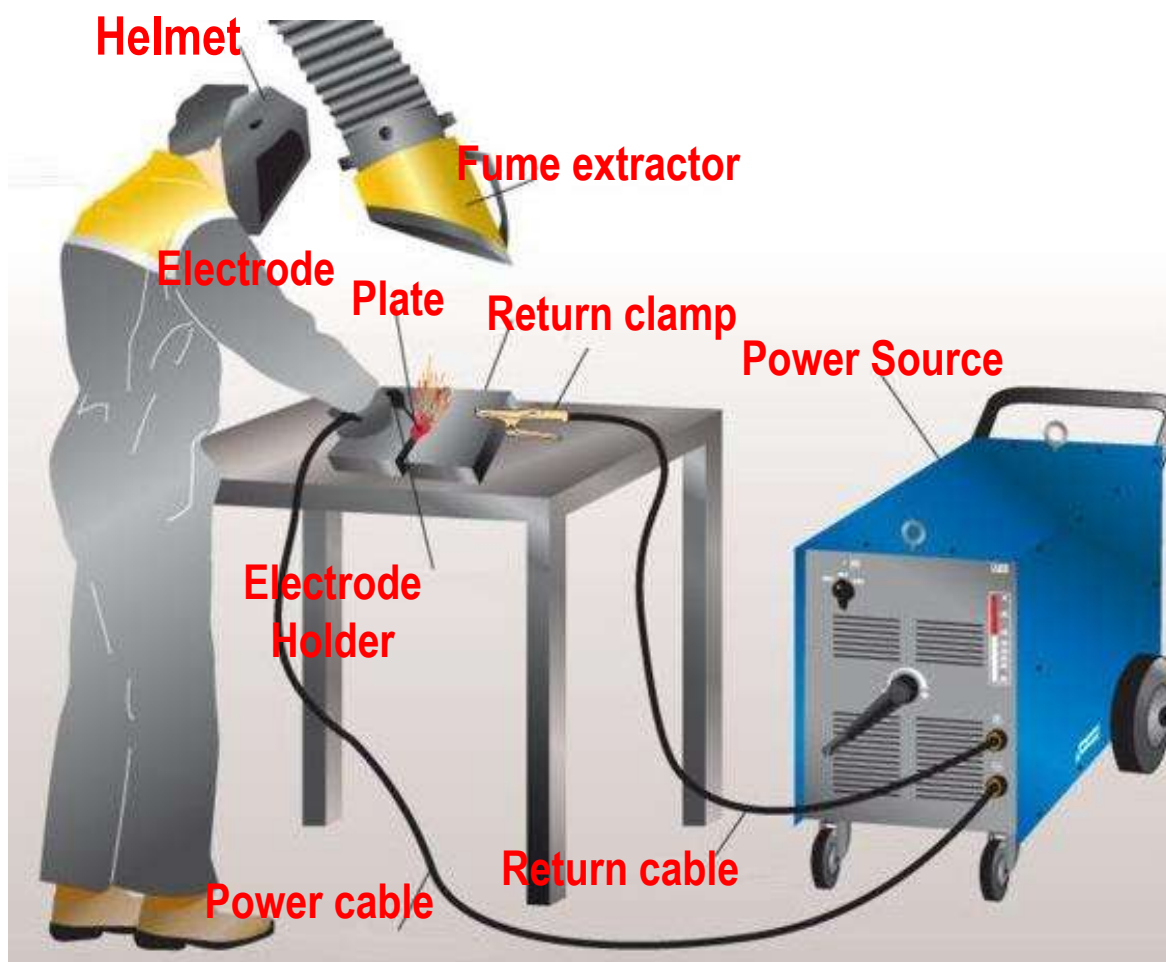

General Welding Aspects – Electrical Conditions

- MMA welding can use both an Alternating (AC) or Direct (DC) electrical current
- When using a DC current the welding electrode generally has a negative polarity, but in certain conditions can be connected to the positive pole.
- The output for a MMA welder is measured in amps
- Amperage values increase as larger diameter electrodes are used to increase the heat input

A MMA Welding Workstation

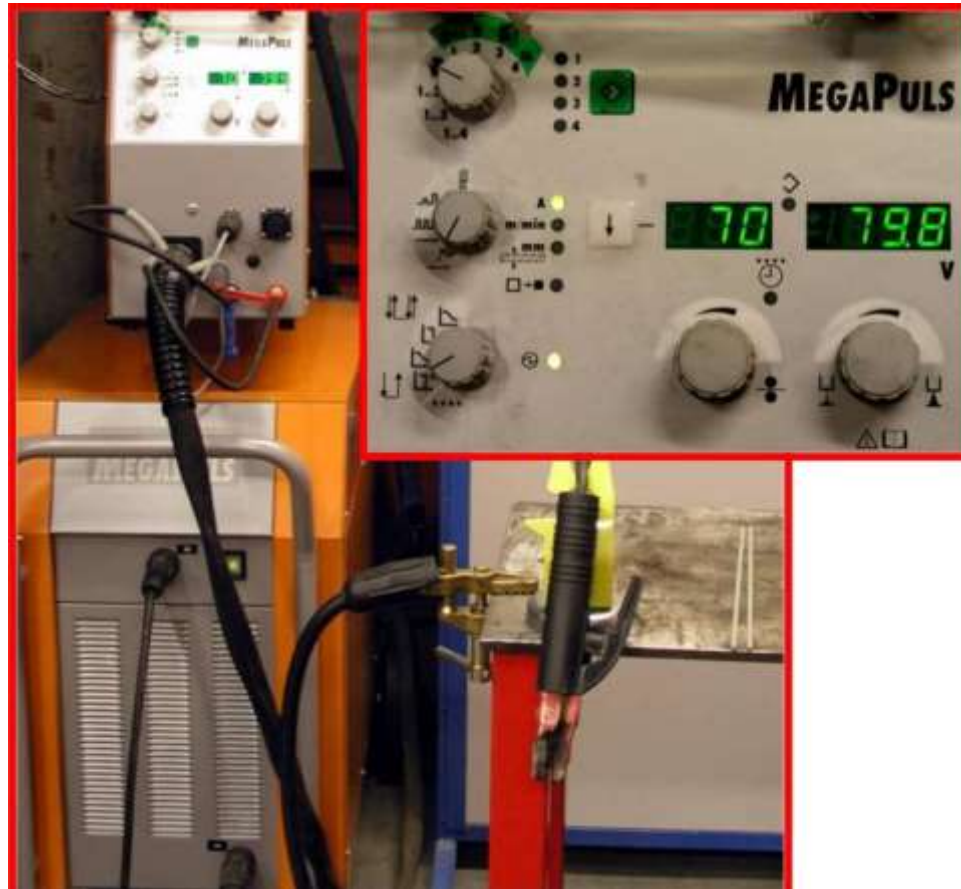

Welding Cables & Connections

- Electricity needs to be a circuit to operate.
- To complete the circuit in welding a current return is connected to the workpiece.
- Electrode holders and current return clamps are rated to match the amperage of the welding set.



Machine Maintenance & Checks

- Due to cooling fans and magnetic fields produced by electrical components the inside of welding sets should be cleaned periodically
- Cables should be inspected for breaks in insulation and loose connections
- Prior to beginning practical tasks, practice welds should be made to ensure safe operation

Arc Striking

- The arc is initiated by stroking the end of the electrode against the plate
- On touching the plate the electrical circuit is established.
- Withdrawing the electrode creates a ionised gap that supports the arc
- Some welding sets have a “hot start” function that provides an increased amperage that assists arc starting and heat input at the beginning of a weld

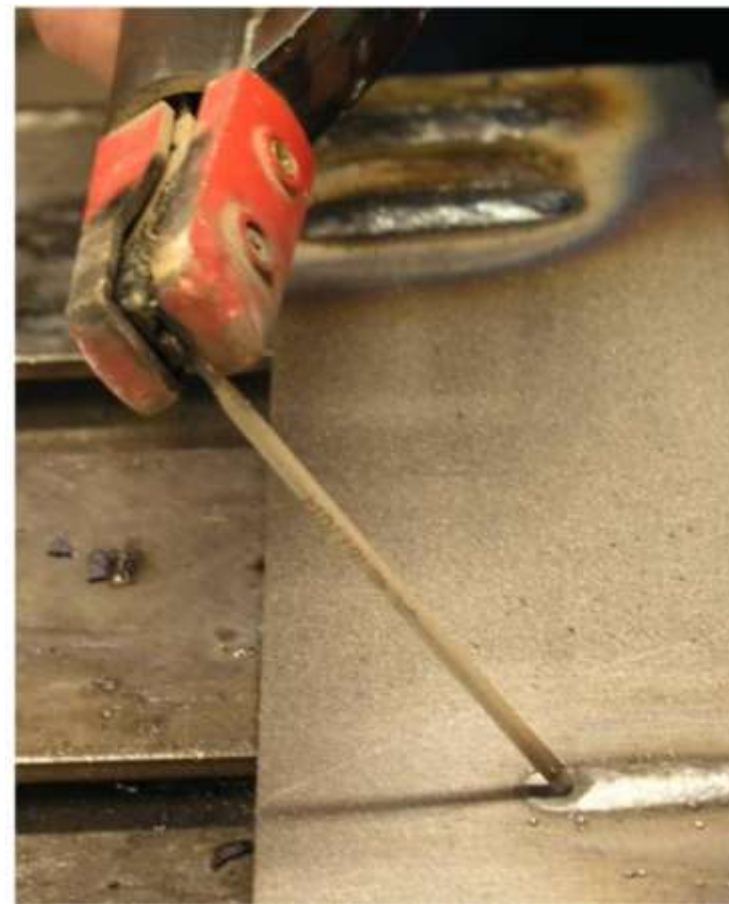

MMA Principle

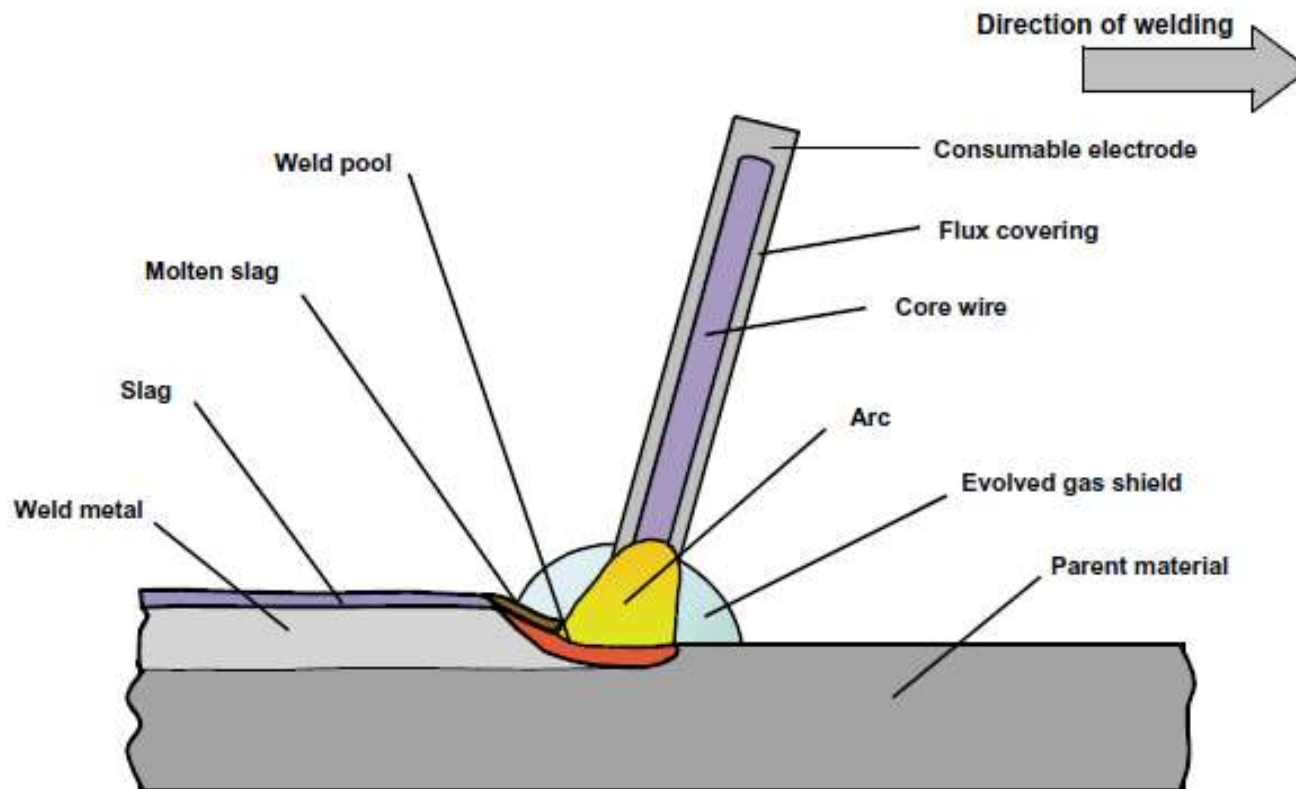

Source: https://www.steelconstruction.info/File:MMA_welding.png

MMA Principle

- The arc is initiated by stroking the end of the electrode against the plate
- The heat of the arc melts both the metal core and electrode covering of the electrode
- The electrode covering produces a shielding gas to protect the molten weld pool (other functions of the electrode covering are discussed later)
- The metal core provides the weld reinforcement

MMA – Metal Core

- The metal core composition should match as closely as possible the metal to be welded
- Small alloying additions can be added to improve the completed weld properties
- The metal core is also the conductor of the electrical current to the arc
- The metal core provides the weld reinforcement
- Diameter of core wire: 1.0 –6.0 mm, length: 200–450 mm.

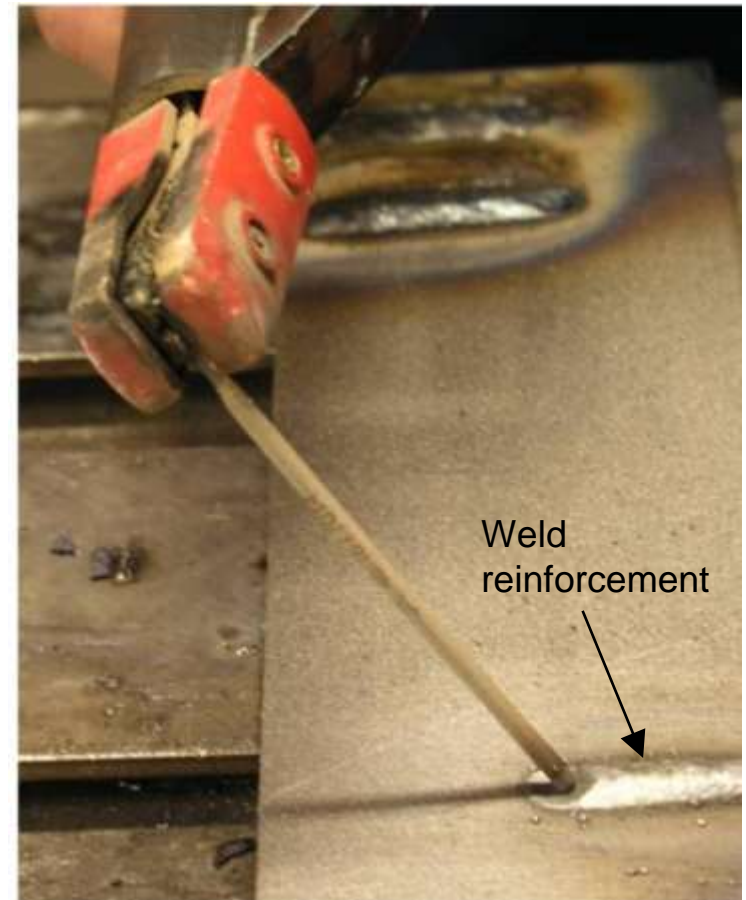

MMA – Flux Coating

- The flux coating of a MMA welding electrodes has many functions

Aids arc initiation and stability during welding

Forms a slag covering to prevent rapid cooling (thermal blanket)

De-oxidises (cleans) the metal surface

Forms a gaseous shield

Adds alloying elements to improve the weld properties

Supplies additional metal to the weld pool (Iron powder electrodes)

Controls size and frequency of transferred metal

Provides appropriate weld contour and penetration

There are four main classifications of electrode coverings

MMA – Electrode Coverings

Types of flux/electrodes

Arc stability, penetration, metal transfer rate and welding position are influenced by the flux coating chemical composition of the welding electrode.

Electrodes can be placed in four main groups:

- Rutile
- Basic
- Cellulosic
- Iron Powder

MMA – Electrode Coverings

Basic electrodes have a high amount of calcium carbonate (limestone) and calcium fluoride (fluorspar) in the coating. This produces a fluid slag coating that is fast-freezing which helps welding in the vertical and overhead position. These electrodes produce high quality, welds with good mechanical properties and resistance to cracking.

Features:

- Low hydrogen weld metal
- Higher welding currents required
- Produces poor bead profile
- Difficult slag removal

MMA – Electrode Coverings

Rutile electrodes contain a high proportion of titanium oxide which enables easy arc ignition, a smooth arc and reduced spatter. Rutile electrodes are general purpose electrodes with good welding properties that can be welded with Ac or DC currents.

Features:

- Good mechanical properties
- Improved weld profile produced
- Positional welding possible
- Slag easily removed

MMA – Electrode Coverings

Cellulosic electrodes contain approximately 30% cellulose in the coating. Adding paper pulp and wood powder to the coating to reduces the amount of cellulose.

The materials in the coating melts to form carbon monoxide, carbon dioxide and hydrogen that increases arc tension and produces a stronger and harder welding arc that can produce 70% deeper weld penetrations. Cellulosic electrodes can be used in the vertical down position with good gap filling possible and produces a thin layer of slag with a large amount of spatter.

- **Features:**
 - Deep penetrating welding in every position,
 - Vertical down welding capability,
 - Weld metal with good mechanical properties.

MMA – Electrode Coverings

Metal powder electrodes contain additional metal powder in the flux coating to increase the maximum welding current.

Iron powder electrodes are generally used in the flat and H/V positions due to higher amperages and deposition rates with easy slag removal.

Increased efficiency of the deposited weld can be as high as 130 to 140%.

Welding Electrodes

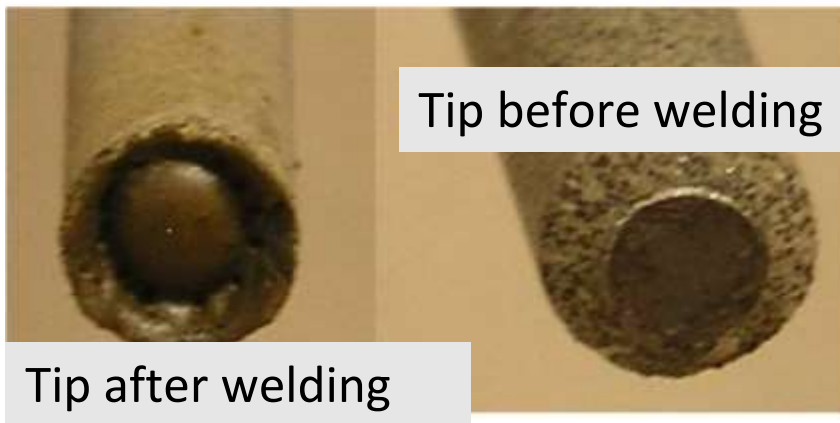

Classification of Covered Electrodes – EN ISO 2560

- ISO EN 2560 classifies covered electrodes
- A code marked on each electrode identifies a range of properties
- Example: **E46 4 B 32 H5**

E – Electrode

46 – Yield Strength – 460 N/mm²

4 - Minimum Impact Temperature at 40J: - 40⁰c

B – Flux Coating – Basic

3 – Current Type – AC + DC

2 – Position – All position except Vertical down

H5 – Hydrogen Controlled – 5ml/100g maximum

Electrode Coatings



Metal Transfer

**Metal transfer depends on the type and thickness of coating.
Thicker coatings produce increased slag.**

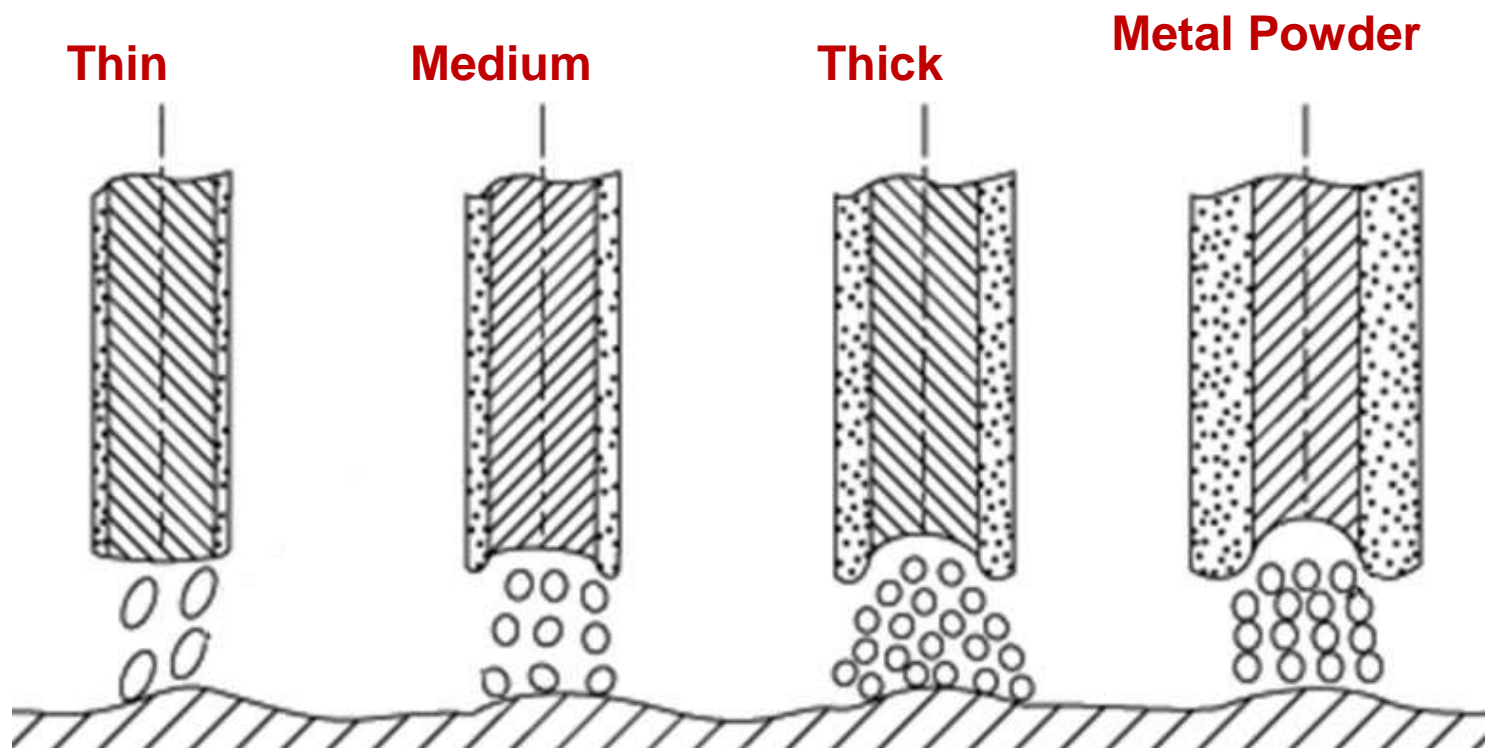

Welding Current Selection

- The required polarity is also important

Diameter (mm)	1.6	2.0	2.5	3.25	4	5	6.3
Welding current (amps)	25-30	40-50	60-80	100-150	140-180	180-300	280-450

Electrode Selection

- Selecting the correct electrode depends on a number of factors:
 - Metal type
 - Metal Thickness
 - Joint Design
 - Welding Position
 - Completed Weld Properties

Resources



- [MMA Welding Tips](#)
- [Basic Set Up](#)

Resources

- [Electrode Selection](#)
- [Welding Calculator](#)

II.3 Tungsten Inert Gas (TIG) Welding



Learning Outcomes

- Knowledge of the TIG welding, arc ignition methods and their most common applications
- Knowledge of the most important applications and selection of the appropriate values for welding parameters
- Use of and care for the equipment and accessories demonstration

Topics

- General Welding aspects
- Specific norms of health & safety
- Control of welding current, instruments to be used and validation of measuring instrument
- Arc starting devices
- Earthing arrangements, cables, welding torches
- Maintenance of equipment, conditions cables and connections,
- Cleanliness of contact faces, cleanliness of internal components, gas supply and control
- Checking for safe operation
- Grinding of tungsten electrodes
- Classification of tungsten electrodes (ISO 6848)
- Classification of welding rods or wires used for TIG welding
- Classification of shielding and backing gases (ISO 14175)
- Size of rod or wire to be used
- Sharpening and handling of tungsten electrodes
- Proper use of backing gases

General Welding Aspects

- TIG = Tungsten Inert Gas
- Also known as GTAW = Gas Shielded Tungsten Welding
- TIG welding uses a non-consumable tungsten electrode to generate the heat for welding
- Filler metal, when required, is added by hand
- Shielding gas protects the weld and tungsten

General Welding Aspects – Basic Equipment

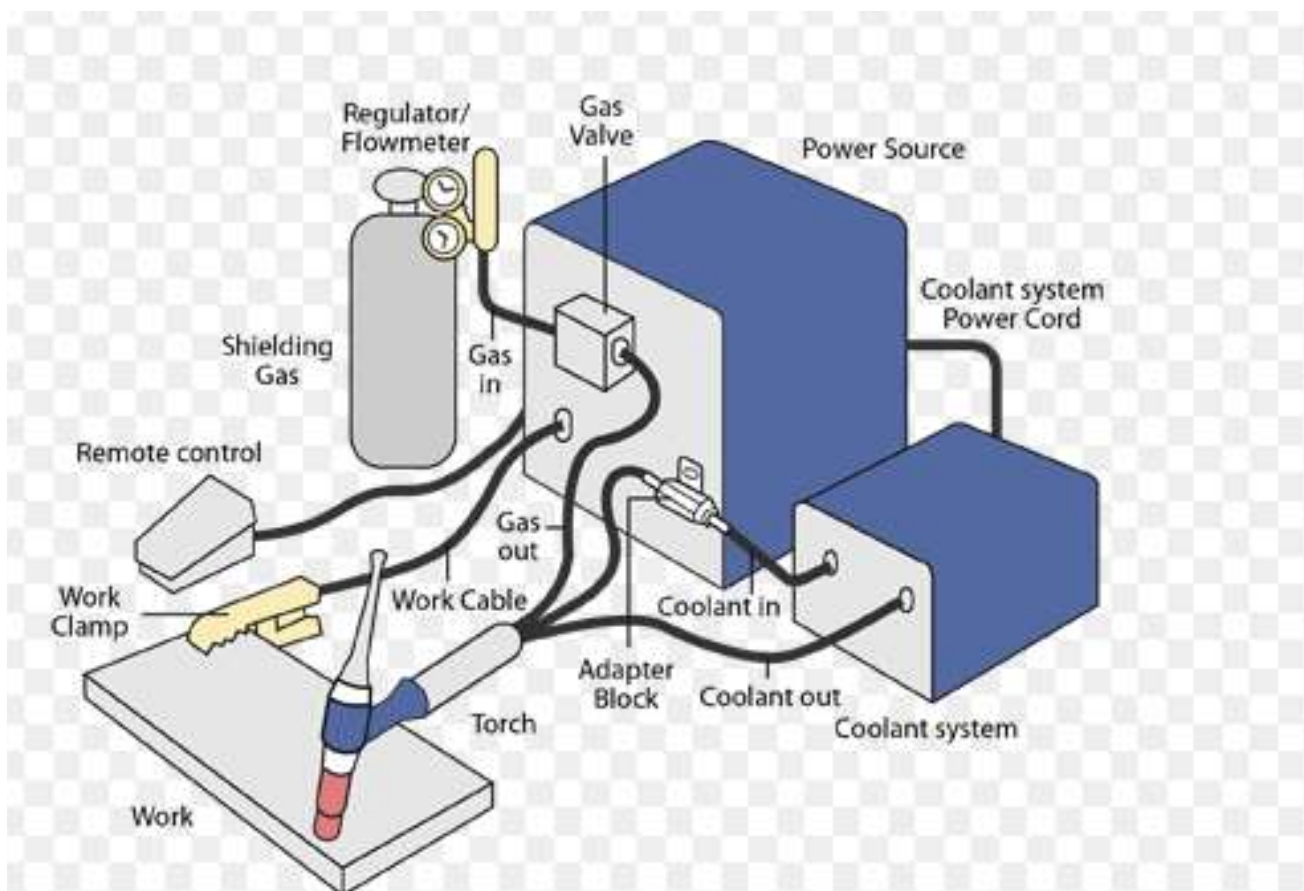

General Welding Aspects – Welding Torch

- TIG torches come in different sizes to suit the welding machine output.
- They need to be light and flexible.
- They can be either air cooled or water cooled
- TIG torches are generally connected to the negative pole.



General Welding Aspects - Process

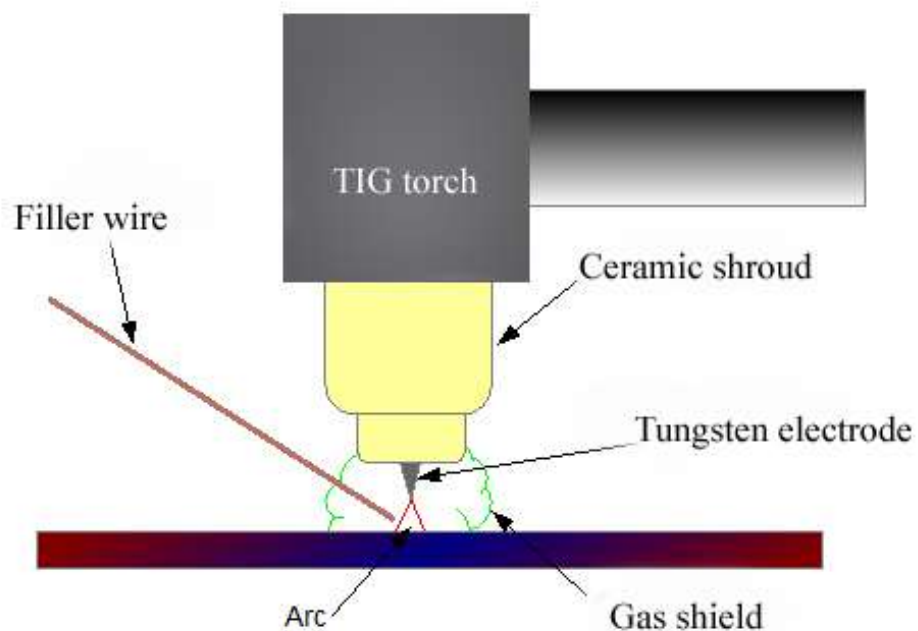

Welding Current

Welding current is generally controlled by a single rotary knob with a LED read-out indicating amps value.

Depending on the complexity of the machine, various other parameters and controls are set on this front panel



Welding Current – Amperage control

- Variations in arc length can effect the welding current
- A drooping characteristic power source ensures these variations are minimised.
- An increase in arc length requires a higher voltage to maintain the arc.
- Increased voltages will reduce the amperage levels

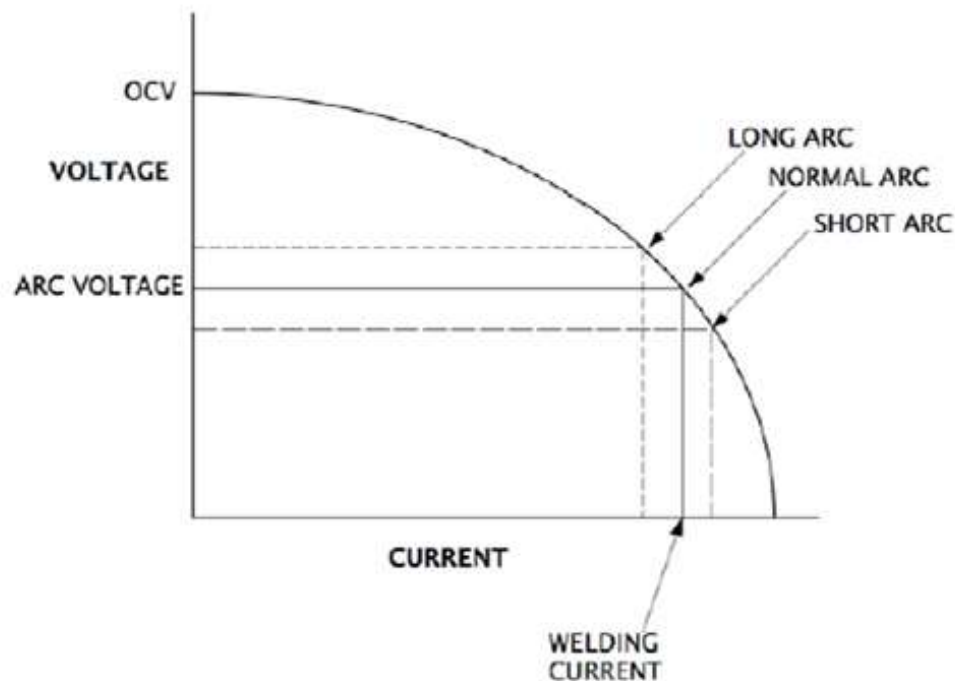

Arc Ignition Devices

There are three main methods of ignition the TIG welding Arc:

- Scratch start – electrode is “scratched” against metal surface
- Lift start – Tungsten placed on metal and trigger pressed. On lifting the torch the arc is established.
- High Frequency (HF) – The HF ionises the air gap which initiates the arc

TIG Welding Cables & Connections

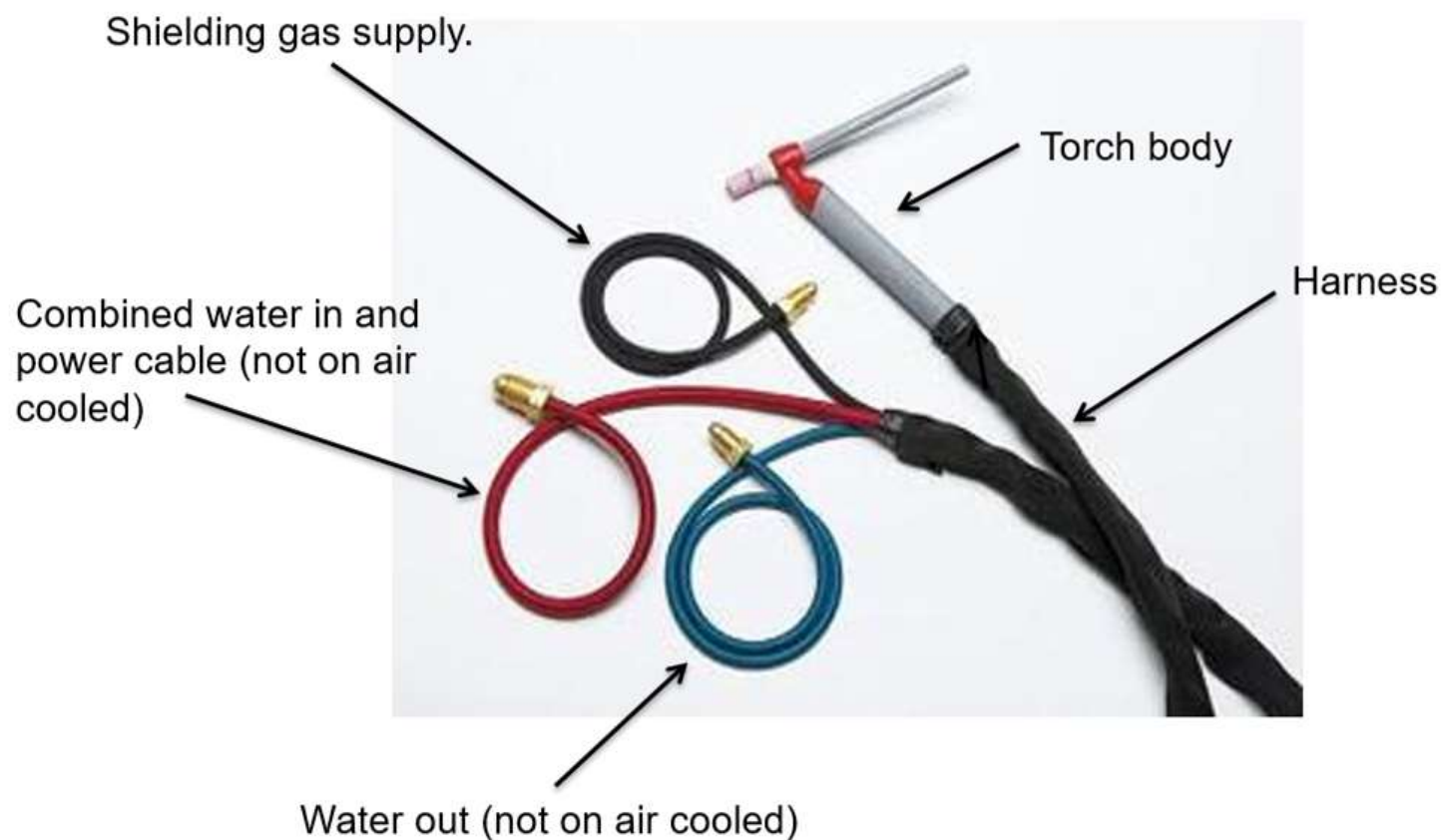

TIG Welding Cables & Connections

- Electricity needs to be a circuit to operate.
- To complete the circuit in welding a current return is connected to the work piece.
- Current return clamps are rated to match the amperage of the welding set.



Machine Maintenance & Checks

- Due to cooling fans and magnetic fields produced by electrical components the inside of welding sets should be cleaned periodically
- Cables should be inspected for breaks in insulation and loose connections
- Gas hoses should be checked for leaks
- Prior to beginning practical tasks, practice welds should be made to ensure safe operation

Gas Supply and Control

- Shielding gases are usually supplied in cylinders but manifold systems are available
- Cylinders are colour coded to identify contents
- High pressure gas supply will need to be reduced by regulators
- Gas flow rates at the torch is controlled by flow meters

Tungsten Electrodes - Grinding

- It is important to sharpen tungsten electrodes correctly.
- Incorrectly ground electrodes can cause arc wander.
- Machines are available to ensure accurate grinding.

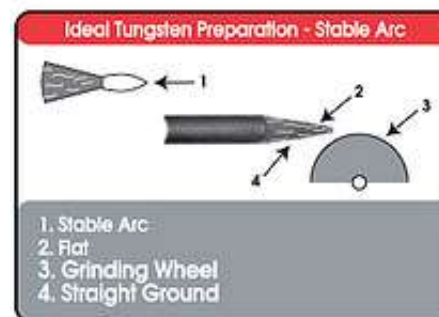
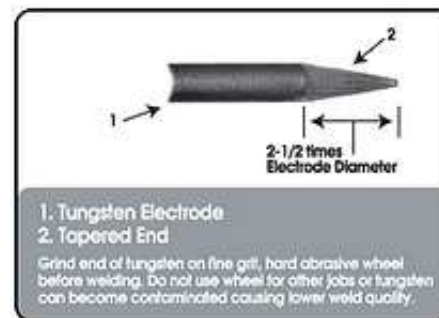

Tungsten Electrodes - Types – ISO 6848

Description	Alloy	Tip colour	Use
Pure Tungsten	100% tungsten	Green	AC only
Thoriated	2% thorium	Red	Steel
Zirconiated	0.8% zirconium	White	Aluminium
Ceriated	2% cerium	Grey	All metals
Lanthanated	1.5% lanthanum	Gold	All metals

- The diameter of the electrode will limit its current (amps) carrying capacity.
- Too small an electrode will overheat.
- Too large an electrode will limit arc heat and lead to poor penetration.

Tungsten Electrodes – Current Capacity

Electrode dia. (mm)	Shroud bore (mm)	Amperage range	
		DC	AC
		Thoriated	Zirconiated
1.6	10	45 - 65	45 - 70
2.4	10	90 - 120	110 - 150
3.2	13	100 - 160	100 - 140

Amperage ranges shown are a guide only

Tungsten Electrodes - Thoriated

- Thoriated tungsten's are identified by a red end
- Thorium is radioactive and care should be taken for storage and sharpening
- Sharpening on open grinding equipment is dangerous and should be avoided
- Thorium is carcinogenic

TIG Filler Wire

- TIG electrode wire is selected to suit the joint
- Material of the wire matches the material being welded
- Various diameters are available
 - $\text{Ø}1$, $\text{Ø}1.6$, $\text{Ø}2.4$, $\text{Ø}3.2$
- As a guide, the diameter of the wire should be slightly smaller than the metal thickness being welded.



TIG Welding Shielding Gases – ISO 14175

- Argon and helium are both inert gases.
- Hydrogen is an active gas.
- Hydrogen and helium increase the heat input, producing a hotter weld with deeper penetration.
- Helium is a light gas, flow rates will need to be increased.

Shielding gases	
Type	Uses
Pure Argon	LCS, Stainless steel, aluminium
Argon/Hydrogen	Austenitic stainless steel
Argon/Helium	Aluminium
Helium	Aluminium

TIG Welding Shielding Gases – Back Purging

- Some materials (Stainless steel, Titanium) require back purging to protect the root of the weld from oxidisation.
- Purging can take place by filling the rear of the weld area with inert gas
- Small components can be welded in an inert container
- Backing tape or jigs can direct gas flow locally to protect the component
- Gas flow rates are usually lower than the main torch flow rate
- Sufficient time should be allowed for the purging gas to remove atmospheric gases

TIG Welding Shielding Gases – Back Purging

- Unpurged



TIG Welding Shielding Gases – Back Purging

- Purged Pipe Bore

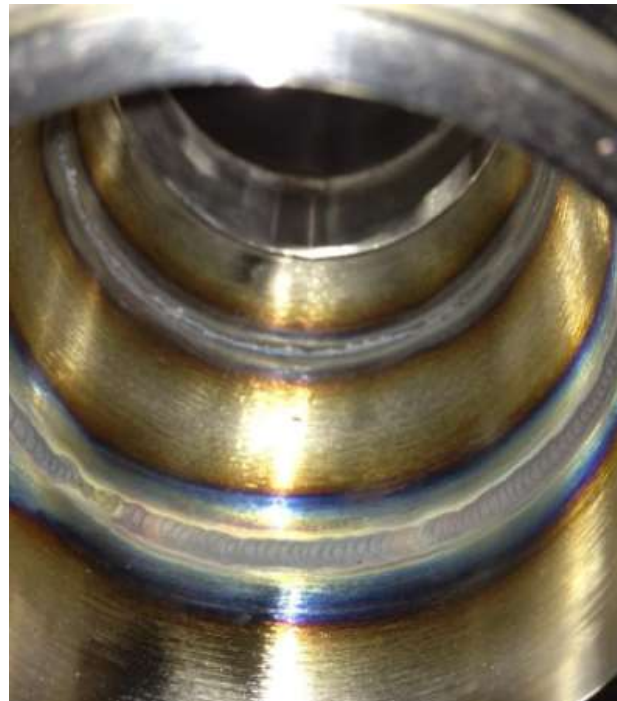

Resources



- [TIG Intro](#)
- [TIG Welding](#)
- [Tungsten Grinding](#)
- [Back Purging](#)

II. Basics of fusion welding processes

II.4. Gas metal arc welding (MIG welding / MAG welding)



Aim & Objectives

Module Aim:	Understand principles of work and equipment use in MIG/MAG welding
Number of hours:	e-learning – 4 hours ; self study – 2 hours
Learning Outcomes:	<ul style="list-style-type: none">• MIG/MAG welding principles description, including metal transfer modes and their applications.• Identification of the most common applications for each type of current, polarity and electrode.• Identification of the application range, appropriate joint preparations and potential problems to be overcome.
ECVET:	

Lecture Outline

- Control of welding current
- Welding guns, cables, grounding (earthen) arrangements
- The wire feed unit
- Maintenance of equipment
- Checking for safe operation
- Welding consumables (wire electrodes and gases)
- Selection of wire types and size
- Application of different types of wire electrode size
- Selection of the shielding gas
- dip (short-circuit) transfer mode, spray transfer mode , globular transfer mode, etc.
- Typical welding parameters
- Welding imperfections
- Torch angle and technique (push and pull)

Gas-shielded metal arc welding (MIG/MAG)

General principles

2016-1-RO01-KA202-024508

The content of the present material is the sole responsibility of the authors, and the National Agency and European Commission cannot be held responsible for any use which may be made of the information contained therein.



Co-funded by the
Erasmus+ Programme
of the European Union

General principles

- The MIG/MAG process is an arc welding process which produces the joint of metals by heating them with an arc between a continuously fed filler metal electrode and the workpiece.
- The process uses shielding from an externally supplied gas to protect the molten weld pool.
- When inert gas is used: MIG welding, and when an active gas is used: MAG welding

General principles

- The application of MIG/MAG welding generally requires DC+ (reverse) polarity to the electrode
- MIG – Metal Inert Gas – Ar, He (shielding gas)
- MAG – Metal Active Gas – CO₂ and O₂ containing gases
- DC – Direct Current

Reverse polarity DC +

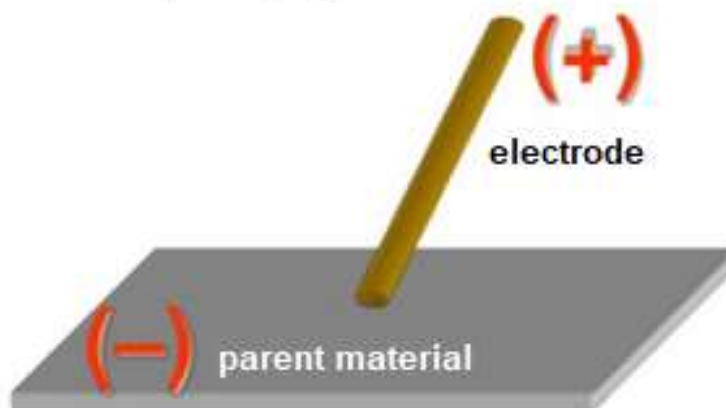

General principles

- A welding arc is dynamic, in which current (A) and voltage (V) are changing constantly. The power source is monitoring the arc and making millisecond changes in order to maintain a stable arc condition
- A “constant power“ welding power supply will maintain the voltage at a relatively constant level, regardless of fairly large changes in current.

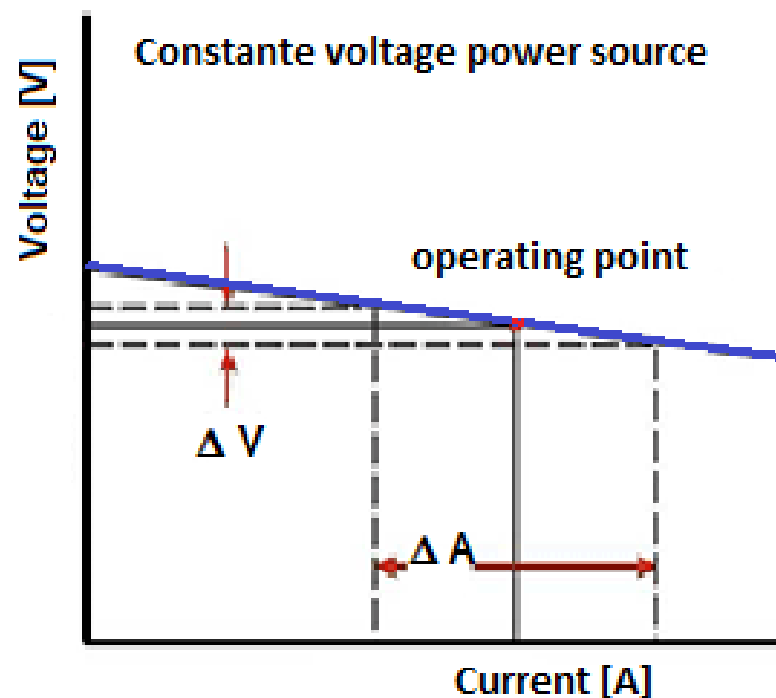

General principles- current vs. voltage

- **Current** effects the melt-off rate of the wire electrode. The higher the current level, the higher the melt-off rate, measured in kilograms per hour (kg/h). The lower the current, the lower the electrode's melt-off rate becomes.
- **Voltage** primarily controls the length of the welding arc which is the distance between the molten weld pool and the wire filler metal at the point of melting within the arc. As the voltage is increased, the weld bead will flatten out more and have an increasing width-to-depth ratio.

Earthen (Ground) arrangements, cables, welding torch

MIG/MAG(GMAW) welding

Earthen arrangements, cables, welding guns

Welding equipment (guns, cables and earthen arrangements)

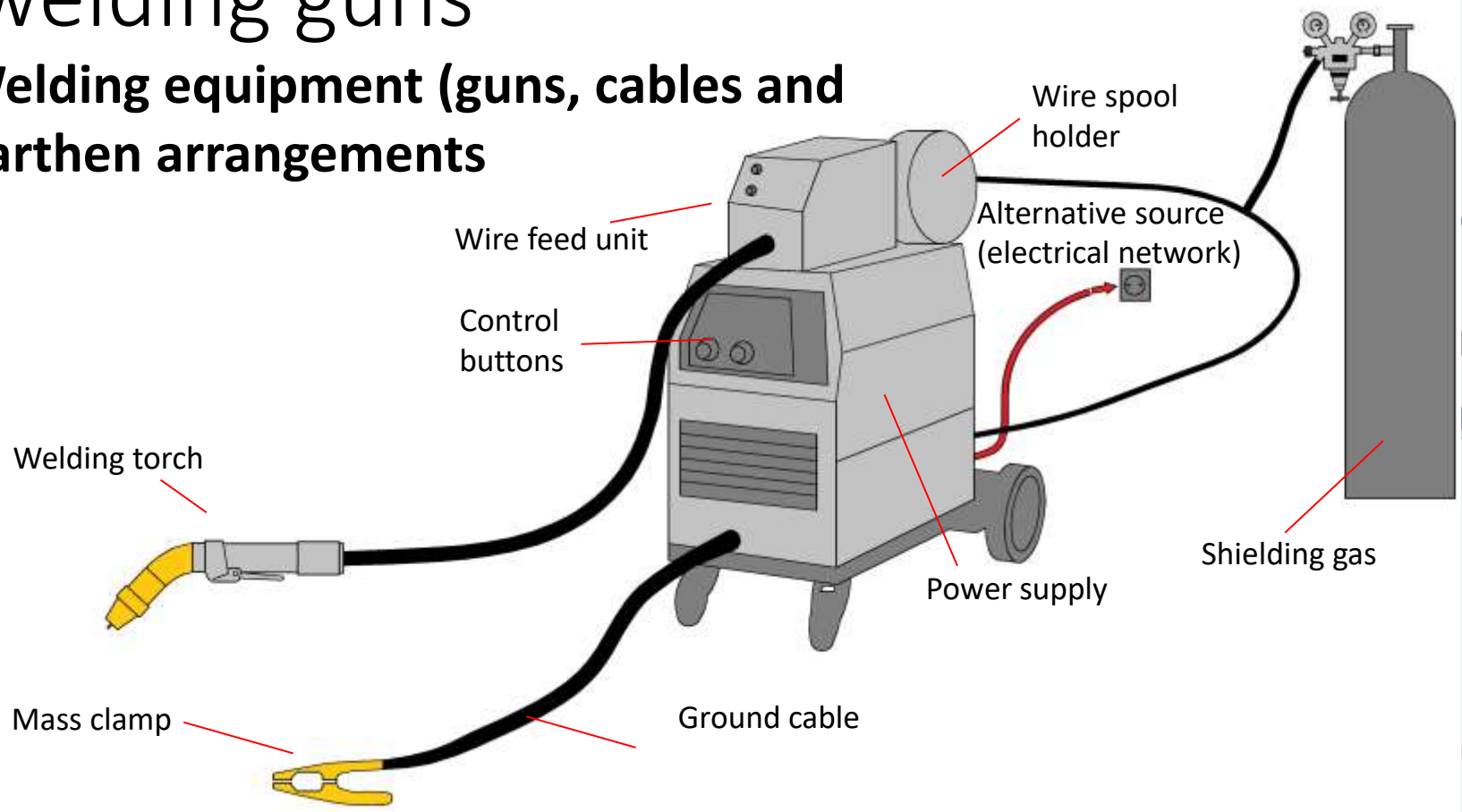

Earthen arrangements, cables, welding guns

EARTHEN SAFETY

- Grounding of electrical circuits is a safety practice.
- Typical arc welding setup consists several electrical circuits.
- Proper grounding method within the welding area is important (promotes electrical safety in the workplace).

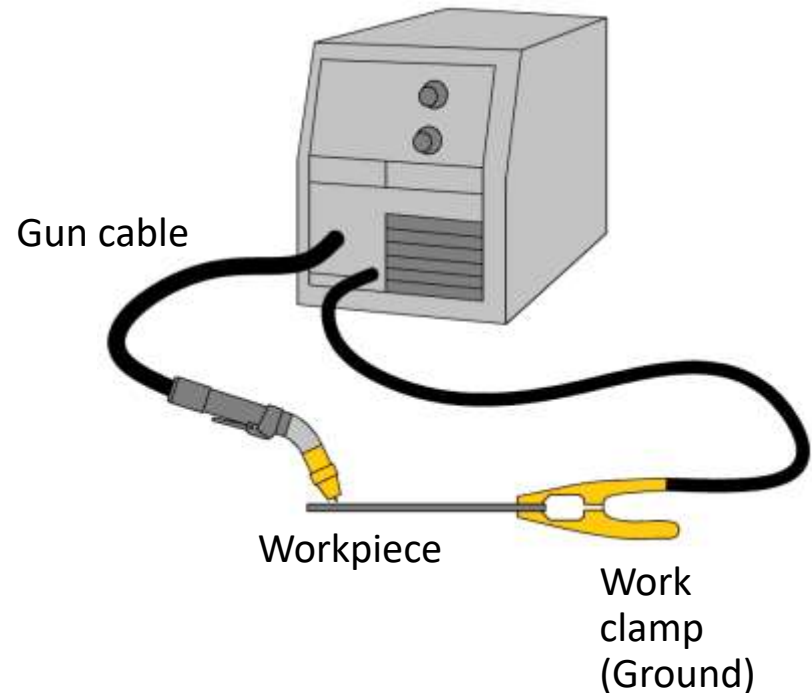

Earthen arrangements, cables, welding guns

WELDING MACHINE GROUND

- Welding machines has a flexible cord and plug arrangements that contains a grounding conductor.
- The grounding conductor connects metal trough the welding machine to ground (earth).

WELDING CIRCUIT HAZARDS

- Utilizing proper grounding in the welding environment is a good practice, but it does not remove all possibility of electrical shock.
- The welding circuit is energized by welding voltage. A person will receive a shock if they become the electrical path across the welding circuit.

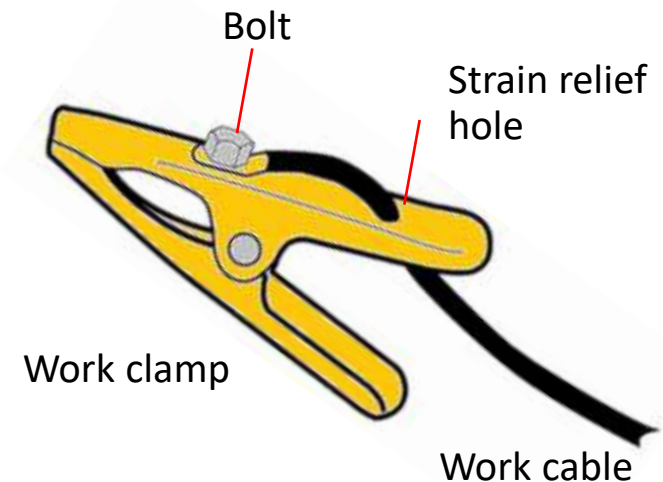

Grounding (earthen) arrangements, cables, welding torch

Welding torchs

There are two types of welding torchs:

1. Air cooled - up to 350 Amperes
2. Water cooled - more than 350 Amperes

Manual torchs are basically the same as torches used for automatic welding.

Only difference is in the shape due to ergonomic.

All elements are the same.

Earthen arrangements, cables, welding guns

Welding guns

1. Air and water cooled

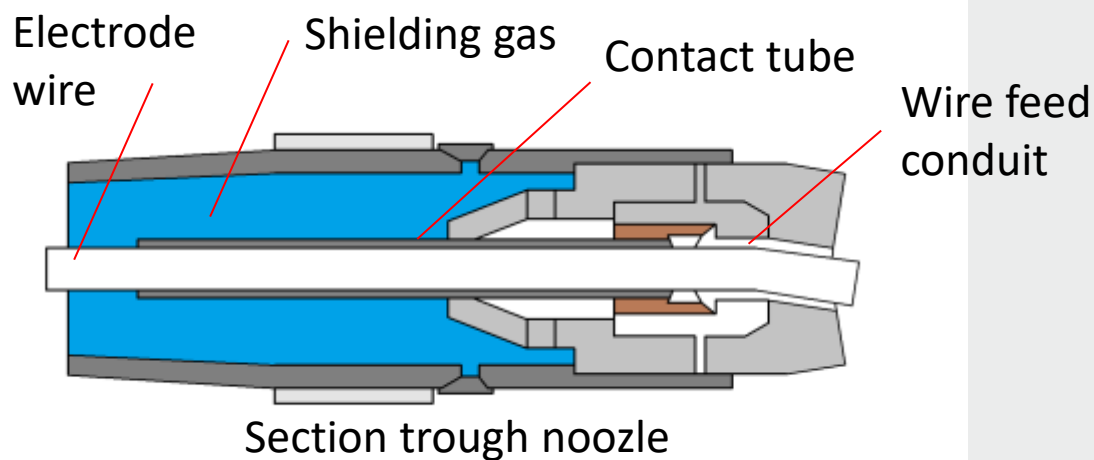
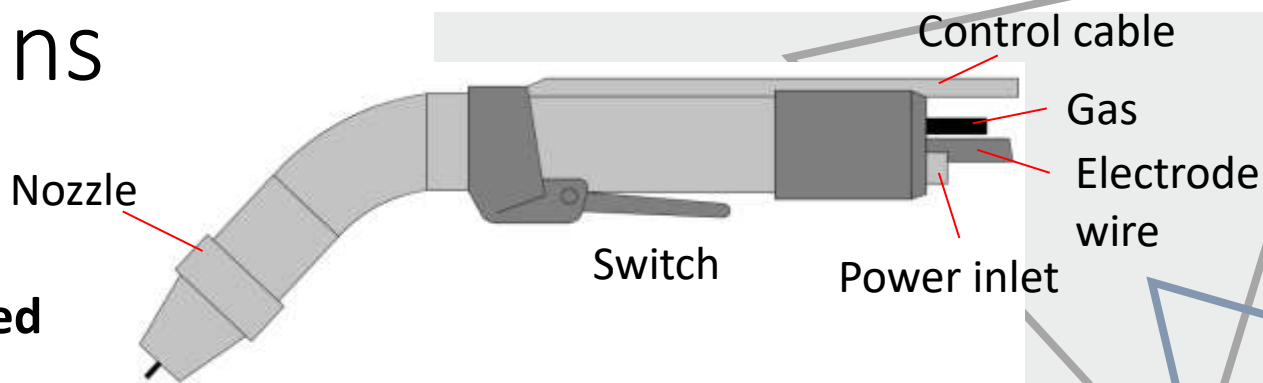

Maintainance of equipment, condition on cables and connections, cleanliness of contact faces, cleanliness of internal components, gas supply and control

MIG/MAG(GMAW) welding

Maintenance of equipment

- Maintenance of welding equipment is one of the most important and simplest way to create strong welds.
- Proper machine maintenance helps to avoid some common welding mistakes and helps to avoid paying for costly repairs due to improperly maintained equipment.
- GMAW maintenance including the gun liner, gun contact tips and the shielding gas hose – and requires much more regular care and attention.
- Machine **MUST ALWAYS** be unplugged before any maintenance tasks!!
- To avoid grime (dust and steel particles), blow out the inside of the machine and wire feeder with clean compressed air.

Maintenance of equipment

- Contact tips are often overlooked for maintenance
- the gun, cone and diffuser are essential to maintain for trouble-free welding performance (components work as a whole. Electrical conductivity and gas dispersion for the GMAW process to occur, you won't be able to weld properly if these elements are not kept in top shape.



Shielding gas nozzle



Gas supply

- Basic gas supply system components are:
 - Gas cylinder
 - Shielding gas
 - Gas pressure regulator



Gas pressure regulator

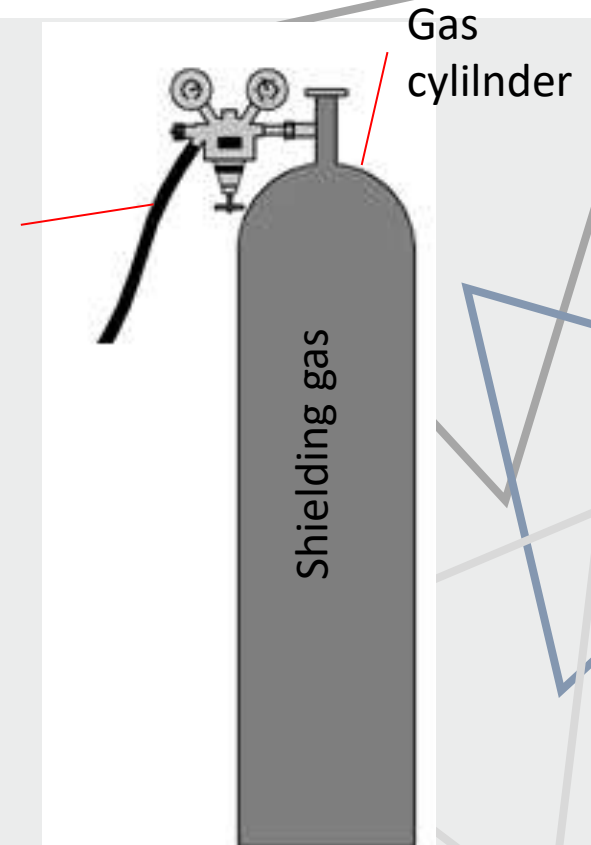

Gas control (Content)

- Shielding gas content can be controlled with primary side of gas pressure regulator (low pressure indicates lack of shielding gas)

Gas flow control

- Shielding gas flow control is maintained with secondary side of gas pressure regulator. Usually set between 10 to 15 litres / minute

Primary side of gas pressure regulator



Gas flow rate setting component

Secondary side of gas pressure regulator

Wire feed unit and its proper operation

MIG/MAG(GMAW) welding

2016-1-RO01-KA202-024508

The content of the present material is the sole responsibility of the authors, and the National Agency and European Commission cannot be held responsible for any use which may be made of the information contained therein.



Co-funded by the
Erasmus+ Programme
of the European Union

Wire feed unit

- Supplies welding wire to workpiece,
- Wire feed unit and its proper operation is very important.
- Basic factor for proper operation of feeder is cleanliness (dust...) and suitable driving roles for each dimension of welding wire. 1 mm wire must have 1 mm roller installed!!!

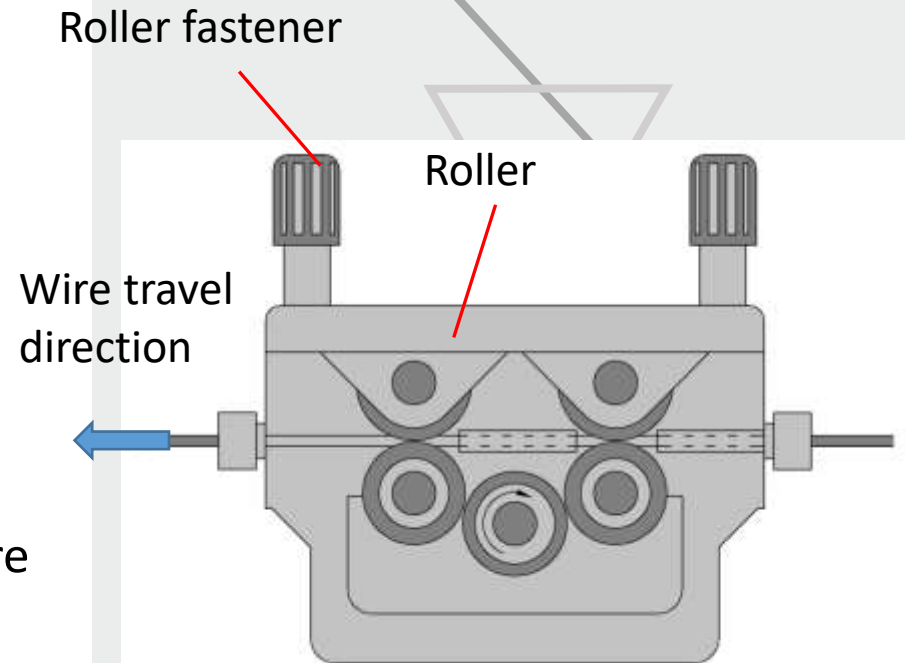

Safe operation

MIG/MAG(GMAW) welding

2016-1-RO01-KA202-024508

The content of the present material is the sole responsibility of the authors, and the National Agency and European Commission cannot be held responsible for any use which may be made of the information contained therein.



Co-funded by the
Erasmus+ Programme
of the European Union

Pre-operational safety checks

- Ensure no slip/trip hazards are present in workspaces and walkways.
- Ensure the work area is clean and clear of grease, oil, and any flammable materials.
- Keep the welding equipment, work area and gloves dry to avoid electric shocks.
- Ensure the gloves, welding gun and work leads are in good condition.
- Ensure other people are protected from flashes by closing curtain to welding bay or erecting screens.
- Ensure fume extraction unit is on before beginning welding operation.
- Ensure the work leads do not create a tripping hazard

Operational safety checks

- Ensure machine is correctly set up for current, voltage, wire feed and gas flow.
- Ensure work return cables make firm contact to provide a good electrical connection.
- Never leave the welder running unattended.
- Take care to avoid flashes.



Safety glasses must be worn at all times in addition to welding mask.

Long and loose hair must be contained.



Appropriate footwear with substantial uppers must be worn.

Close fitting/protective clothing to cover arms and legs must be worn.



Housekeeping

- Switch off the machine and fume extraction.
- Close gas cylinder valve.
- Hang up welding gun and welding cables.
- Leave the work area in a safe, clean and tidy state.



Respiratory protection devices may be required for some operations.

Oil free leather gloves and spats must be worn when welding.



Rings and jewellery must not be worn.

A welding mask with correct grade lens for GMAW must be worn.



Selection of wire type and size

MIG/MAG(GMAW) welding

Wire type selection

At MIG/MAG (GMAW) a welding wire has function to **maintene stable welding arc** and is also a **filler material**.

Welding wire selection is based on:

- Parent material and its mechanical properties
- Type and size of construction load
- Purity of parent material

Parent (base) material and its mechanical properties

Welding wire has to be chemically similar to base material with slightly larger contents of alloy elements (Si, Mn..)

Welding wire is normaly deliverable from 0,6 mm thickness (welding of thin materials) to 1,6 mm (welding of thick materials).



Wire type selection

Type and size of construction load

If heavy load construction is welded, than welding wire with addition of Al, Ti in Zr, should be used. Those wires produce welds with better weld microstructure because grain size is smaller and contributes to higher toughness of weld.

Purity of parent material

The most common types of MIG wire for welding mild steel are G 49A 2 C S3 (EN ISO 14341) and (G 42 5 M/C G3 Si1). These wires are designed to met minimum tensile strength requirements.

G 49A 2 C S3 is typically used on clean material (no oil and rust). It is also the best choice for avoiding silicon islands, which can sometimes form on the top of the weld, (shiny/glassy) surface.

G 42 5 M/C G3 Si1 is used for welding on plate that has mill scale or surface contaminants, since this wire has deoxidizers to resolve these issues. A deoxidizers absorbs oxygen so that it vaporizes. Wire is also better for creating a smooth transition (weld to the base metal).

Classifications of welding consumables (wire electrodes and shielding gases)

MIG/MAG(GMAW) welding

Wire electrodes for MIG/MAG welding

Classification standard

EN ISO 14341 – Non-alloy and fine grained steels

EN ISO 14341: A – Classification by yield strength and 47 J impact energy

Example: ISO 14341-A-G 46 5 M21 3Si1

G = Wire electrode

46 = strength and elongation (see EN ISO 14341- table 1A)

5 = Impact properties (see EN ISO 14341- table 2)

M21 = Shielding gas M21 acc. to EN ISO 14175

3Si1 = Chemical composition of wire electrode (see EN ISO 14341- table 3A)

Wire electrodes for MIG/MAG welding

Classification standard

ISO 18273 – Aluminium and aluminium alloys

Example:

ISO 18273 S Al 4043 (AlSi5)

S = Wire product form (S = Solid wire electrode)

Al 4043 = Numerical designation for chemical composition of wire electrode

(see EN ISO 18273- table 1)

AlSi5 = Chemical designation for chemical composition of wire electrode

(see EN ISO 18273- table 1)



Shielding gases for MIG and MAG welding

Classification standard
EN ISO 14175

Symbolic designation		Componets volume percentage content					
Main Group	Sub-Group	CO ₂	O ₂	Ar	He	H ₂	N ₂
I	1	/	/	100	/	/	/
	2	/	/	/	100	/	/
	3	/	/	rest	0,5 ≤ He ≤ 95	/	/
M1	1	0,5 ≤ CO ₂ ≤ 5	/	rest ^(a)	/	0,5 ≤ H ₂ ≤ 5	/
	2	0,5 ≤ CO ₂ ≤ 5	/	rest ^(a)	/	/	/
	3	/	0,5 ≤ O ₂ ≤ 3	rest ^(a)	/	/	/
	4	0,5 ≤ CO ₂ ≤ 5	0,5 ≤ O ₂ ≤ 3	rest ^(a)	/	/	/
M2	0	5 ≤ CO ₂ ≤ 15	/	rest ^(a)	/	/	/
	1	15 ≤ CO ₂ ≤ 25	/	rest ^(a)	/	/	/
	2	/	3 ≤ O ₂ ≤ 10	rest ^(a)	/	/	/
	3	0,5 ≤ CO ₂ ≤ 5	3 ≤ O ₂ ≤ 10	rest ^(a)	/	/	/
	4	5 ≤ CO ₂ ≤ 15	0,5 ≤ O ₂ ≤ 3	rest ^(a)	/	/	/
	5	5 ≤ CO ₂ ≤ 15	3 ≤ O ₂ ≤ 10	rest ^(a)	/	/	/
	6	15 ≤ CO ₂ ≤ 25	0,5 ≤ O ₂ ≤ 3	rest ^(a)	/	/	/
M3	7	15 ≤ CO ₂ ≤ 25	3 ≤ O ₂ ≤ 10	rest ^(a)	/	/	/
	1	25 ≤ CO ₂ ≤ 50	/	rest ^(a)	/	/	/
	2	/	10 ≤ O ₂ ≤ 15	rest ^(a)	/	/	/
	3	25 ≤ CO ₂ ≤ 50	2 ≤ O ₂ ≤ 10	rest ^(a)	/	/	/
	4	5 ≤ CO ₂ ≤ 25	10 ≤ O ₂ ≤ 15	rest ^(a)	/	/	/
C	5	25 ≤ CO ₂ ≤ 50	10 ≤ O ₂ ≤ 15	rest ^(a)	/	/	/
	1	100	/	/	/	/	/
Z	2	rest	0,5 ≤ O ₂ ≤ 30	/	/	/	/
	/	Special gases and mixtures					

^(a) Argon can be fully or partially substituted with helium.

Application of different types of wire electrode size

MIG/MAG(GMAW) welding

Wire electrode sizes

Examples for choosing appropriate dimension of welding wire for welding of steels

Material thickness (mm)	Solid wire diameter (mm)			
	0,6	0,8	1	1,2
0,8	x	x	-	-
1	x	x	-	-
1,2	x	x	x	-
1,6	-	x	x	-
2	-	x	x	x
3	-	x	x	x
5	-	-	x	x
8 or more	-	-	-	x

Selection of shielding gas

MIG/MAG(GMAW) welding

Selection of shielding gases

MIG welding – METAL **INERT** GAS

Inert mixtures are used at this welding process. Function of those gases is just to shield welding area from the atmosphere.

Those gasses are: ARGON and HELIUM → They can be mixed together.

Designation according to EN ISO 14175: I1, I2 and I3

The most common application of MIG welding of colored metallurgy materials and it's alloys.

Cross-section of weld depend on gas used.

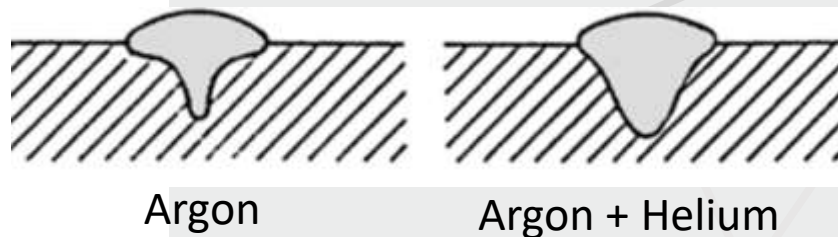

Selection of shielding gases

MAG welding – METAL ACTIVE GAS

Basic shielding gas for MAG welding is CO₂. → EN ISO 14175: C1

Most common gas mixtures for welding are CO₂ + Ar. → EN ISO 14175: M21, M12

MAG welding gases are mostly used for welding of steels.

Cross-section of weld based on gas used.

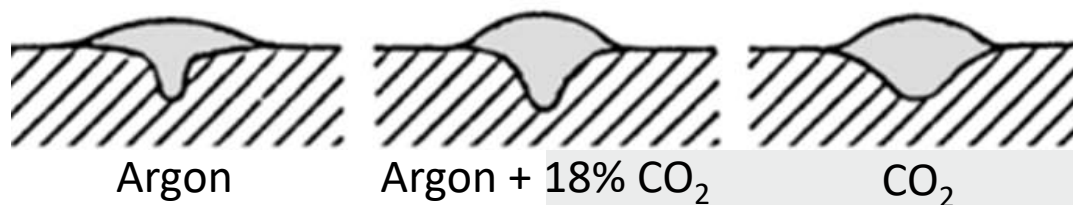

Selection guide of shielding gases

Base material	Shielding gas
Low alloy steel	100% CO ₂ , 75-80% Argon + 20-25% CO ₂ 95% Argon + 5% CO ₂
Carbon steel	100% CO ₂ , 75-90% Argon + 10-25% CO ₂ 82-98% Argon + 2-18% CO ₂ 90% Argon + 7.5% CO ₂ + 2.5% Oxygen
Austenitic stainless steel	98% Argon + 2% CO ₂ 97-99% Argon + 1-3% hydrogen 98-99% Argon + 1-2% Oxygen
Aluminium	100% Argon 100% Helium 75% Argon + 25% Helium 75% Helium + 25% Argon
Copper alloys	100% Argon 75% Argon + 25% Helium 75% Helium + 25% Argon
Nickel alloys	90% Helium + 7.5% Argon + 2.5% CO ₂ 75% Argon + 25% Helium 75% Helium + 25% Argon

Metal transfer

MIG/MAG(GMAW) welding

2016-1-RO01-KA202-024508

The content of the present material is the sole responsibility of the authors, and the National Agency and European Commission cannot be held responsible for any use which may be made of the information contained therein.



Co-funded by the
Erasmus+ Programme
of the European Union

Modes of metal transfer

- (a) Short-circuit (dip) transfer
- (b) Globular transfer
- (c) Spray transfer
- (d) Pulsed transfer

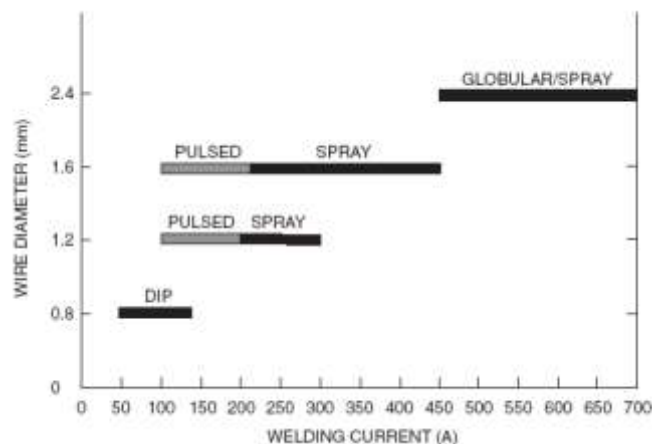
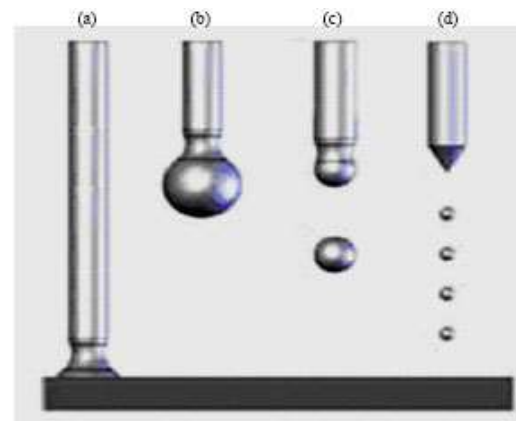

Short-circuit (dip) transfer (D)

- Alternating ignition and shutdown of the electric arc
- 20 to 100 short circuits per second
- Low: I , d_e , $U < 20V$
- Shielding gas: CO_2
- Welding of thin materials in all positions
- For welding of non-alloy and stainless steels
- Low deformations

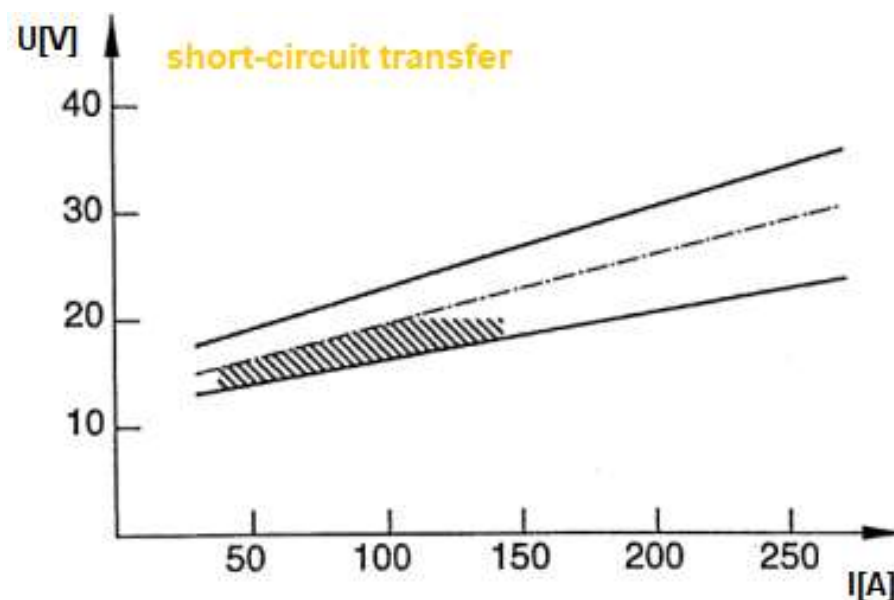

<https://www.youtube.com/watch?v=s4iUzqLtYPQ>

Globular transfer(G)

- Droplets diameter greater than wire diameter
- 100 droplets per second
- Low current density, $U > 20V$
- Shielding gas: CO_2 nad Ar/CO_2
- Welding of non-alloys and low-alloy steels: CO_2 nad Ar/CO_2
- Welding of high-alloy steels: $Ar/1-5\% O_2$ or $Ar/1-5\% CO_2$.
- Welding of BW and FW

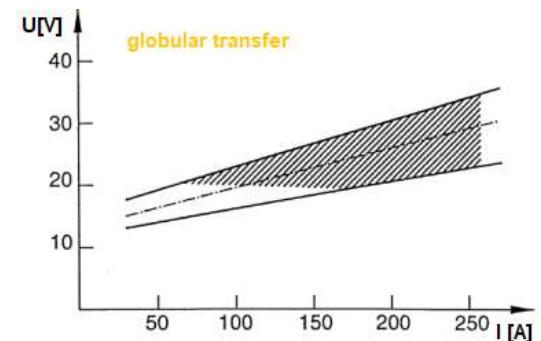

Spray transfer(S)

- Droplets diameter equal or less than wire diameter
- 100-300 droplets per second
- Steel welding with: Ar, He >80 % + active gas
- Non-ferrous metals welding with inert gas: Ar, He
- The pointed tip of the wire electrode (pencil like)
- High welding currents

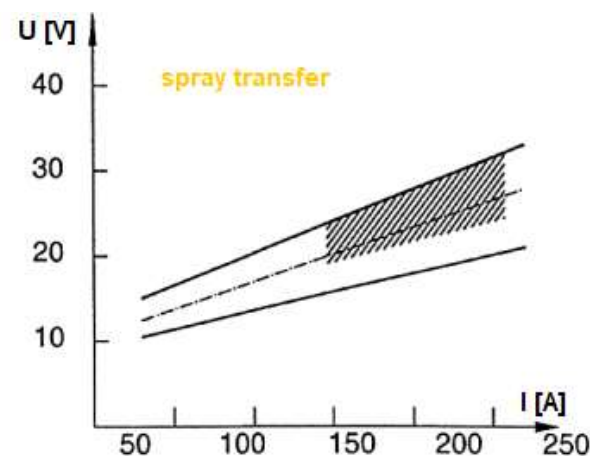

Pulsed transfer(P)

- The basic welding current is increased with additional currents for more controlled droplets transfer
- Welding of thinner materials in all positions
- Control of weld spatter and the elimination of incomplete fusion defects
- Reduced levels of heat induced distortion.
- 60-120 droplets per second
- Shielding gas: > 80 % Ar

<https://www.youtube.com/watch?v=rxqdtYJ71YQ>

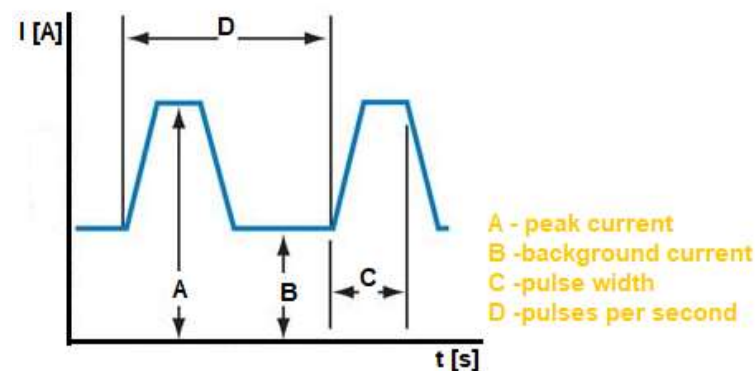

Controlled transfer of metal

- STT (Surface Tension Transfer) - Lincoln

STT uses current controls to adjust the heat independent of wire feed speed, so changes in electrode extension do not affect heat

https://www.youtube.com/watch?v=7NUXnV_ZLzo

- CMT (Cold Metal Transfer)- Fronius

The digital process control detects a short circuit and then helps to detach the droplet by retracting the wire: during welding, the wire moves forward and is pulled back again as soon as the short circuit occurs. As a result, the arc only introduces any heat for a very brief period during the arc-burning phase.

<https://www.fronius.com/en/welding-technology/our-expertise/welding-processes/cmt>

Welding parameters

MIG/MAG(GMAW) welding

Welding parameters in MIG/MAG

- Welding current
- Arc voltage
- Wire feed rate
- Wire diameter
- Travel speed
- Electrical extension
- Distance contact tube to work piece
- Gas flow rate
- Torch angle

Welding current

- The welding current is higher for a higher wire feed rate. This resulting in a reduction of the length of the electric arc with minimal voltage reduction (the voltage is almost constant).
- Higher current means:
 - higher bead
 - deeper penetration
 - higher melting rate
 - higher deposition rate

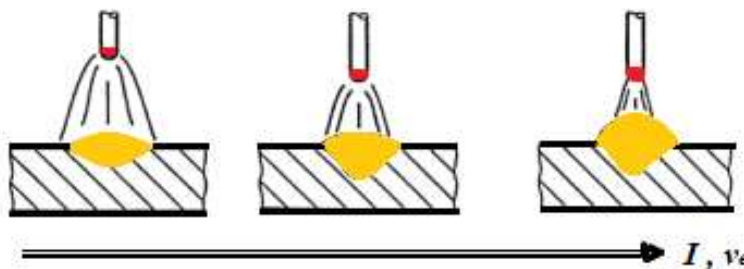

- Wire feed rate have the same effects as welding current!

Control of welding current

- We can measure the welding current using a “shunt” in combination with AD card on PC or with measuring clamps.

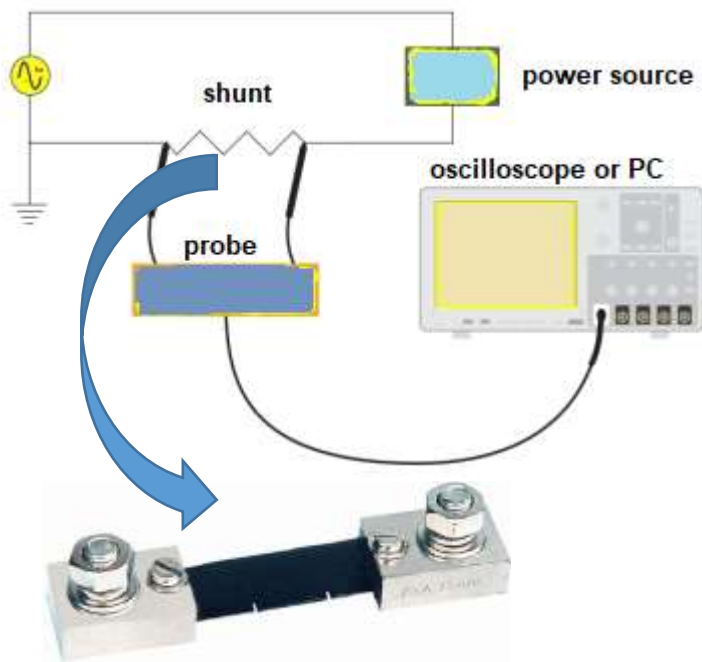

Arc voltage

- The voltage depends on the length of arc, and it is set on the welding machine.
- For the selected welding current (set wire feed rate), we can chose different voltages
- Higher arc voltage means:
 - wider weld
 - shallower penetration

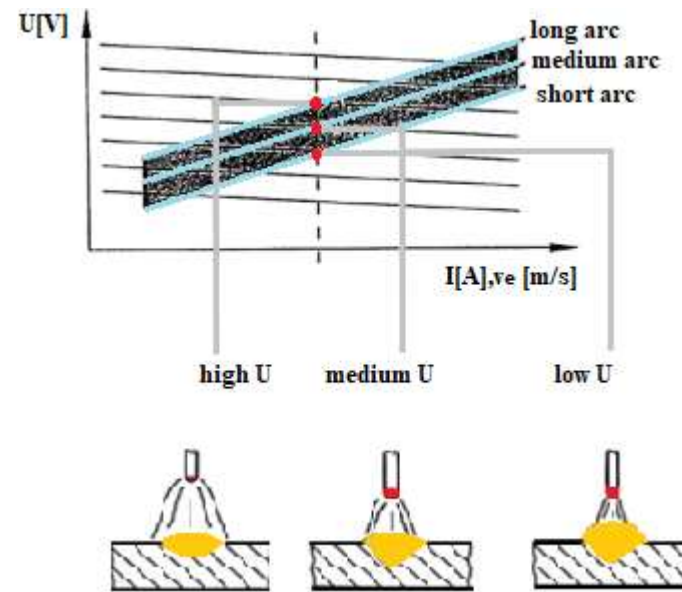

Welding (travel) speed

- The welding speed is related to the energy input in the piece:

$$Q = \frac{U I}{v} \eta$$

Q - heat energy

U - voltage

I - current

η - efficiency of welding process

v - welding speed

- Higher welding speed reduce heat energy in welding piece. This means: narrow weld, low bead, shallow penetration.

Electrode extension

- The electrode extended from the end of the contact tip to the arc is properly known as electrode extension. The popular term is electrical stickout (ESO). In GMAW, this is the amount of electrode that is visible to the welder.

Too large extension means:

- higher voltage,
- higher wire heating due the resistance,
- more spattering,
- lower arc stability,
- higher porosity

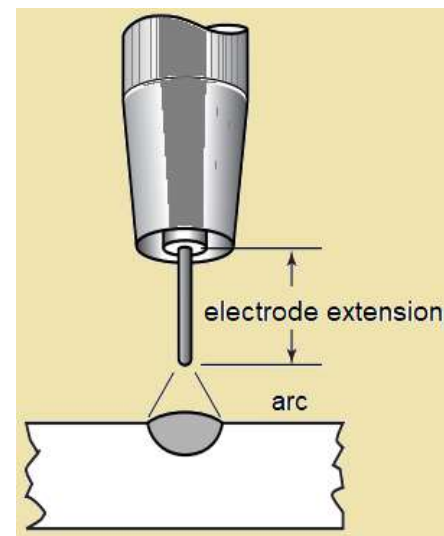

Distance contact tube to work piece

- Also known as Contact Tip to Work Distance (CTWD). This distance must be optimal. If the nozzle is too close to the weld, it gets overheated and contaminates inside with the spatters, what disrupts the flow of the shielding gas. If the distance is too high, the protection of the gas welding area is poor, and the stability of the arc also decreases.

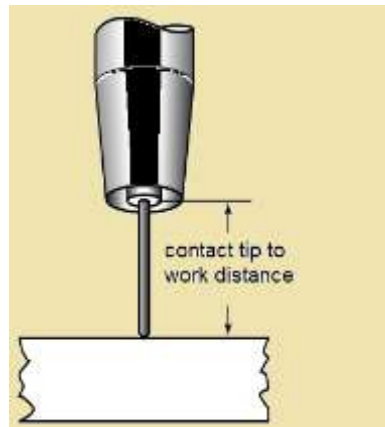

Gas flow rate

- The gas flow rate is set according to several factors. Greater welding nozzle, thicker welding wire, higher welding speed, forced welding positions, joint type and higher welding currents require larger amounts of gas. For steels the following values can be applied:
- $I < 150 \text{ A}$ (8 - 12 L/min),
- $150 \text{ A} < I < 350 \text{ A}$ (12 - 15 L/min),
- $I > 350 \text{ A}$ (15 - 20 L/min).



The gas flow rate is adjusted with manometers or measuring tube-rotameter.

Torch angle and technique (push/pull)

- It can be welded in the forward direction (push) or backward (pull).
- Push technique: for thin materials and root pass – shallow penetration, wider weld, more spatters and porosity.
- Pull technique: for thick materials and filling pass – deep penetration, higher bead.

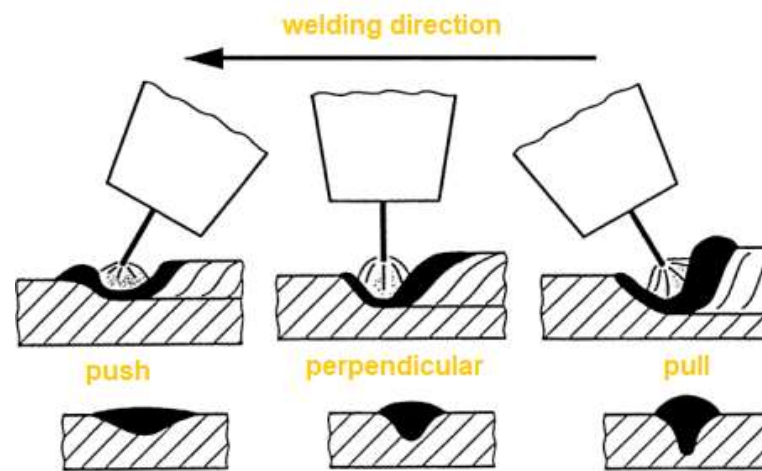

Welding imperfections

MIG/MAG(GMAW) welding

2016-1-RO01-KA202-024508

The content of the present material is the sole responsibility of the authors, and the National Agency and European Commission cannot be held responsible for any use which may be made of the information contained therein.



Co-funded by the
Erasmus+ Programme
of the European Union

Welding imperfections

- cracks
- lack of fusion
- incomplete root fusion or penetration
- porosity
- slag inclusions
- undercuts
- spatters

Cracks

- There are three factors which combine to cause cracking:
 - tensile stresses acting on the welded joint
 - hydrogen generated by the welding process
 - a hard brittle structure which is susceptible to cracking
- **Hot cracks** ($T > 1200^{\circ}\text{C}$, during solidification)
- **Cold cracks** (at room temperature, diffusible hydrogen)

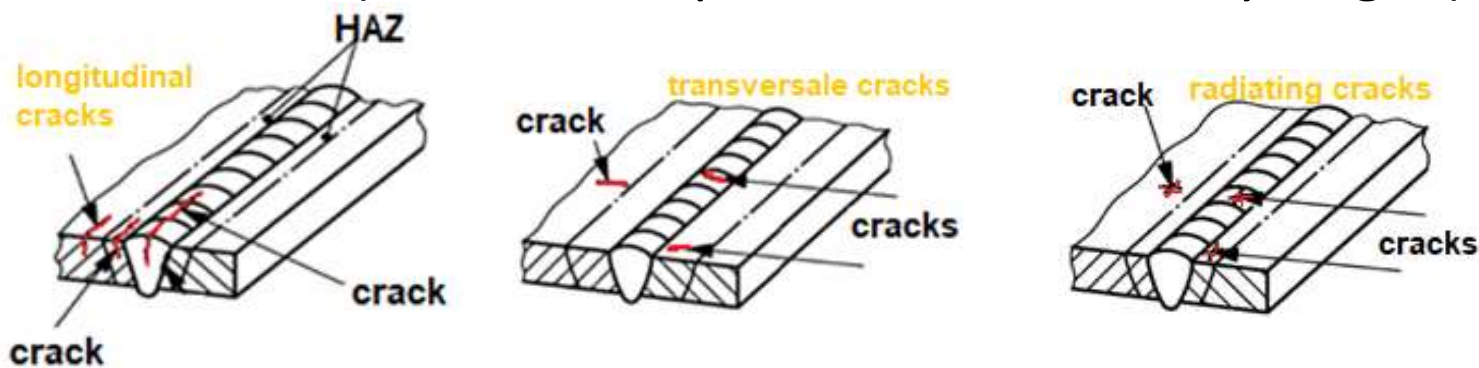

Lack of fusion (LOF)

- The principal causes are too narrow a joint preparation, incorrect welding parameter settings, poor welder technique and magnetic arc blow.
- Too high a current or too low a welding speed will cause weld pool flooding ahead of the arc resulting in poor or non-uniform penetration.

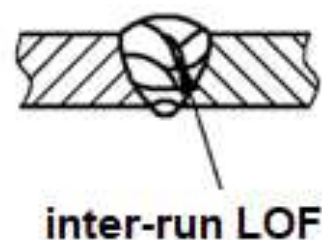
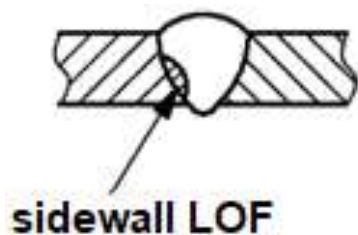

Incomplete root fusion or penetration

- Incomplete root fusion is when the weld fails to fuse one side of the joint in the root. Incomplete root penetration occurs when both sides root region of the joint are unfused.

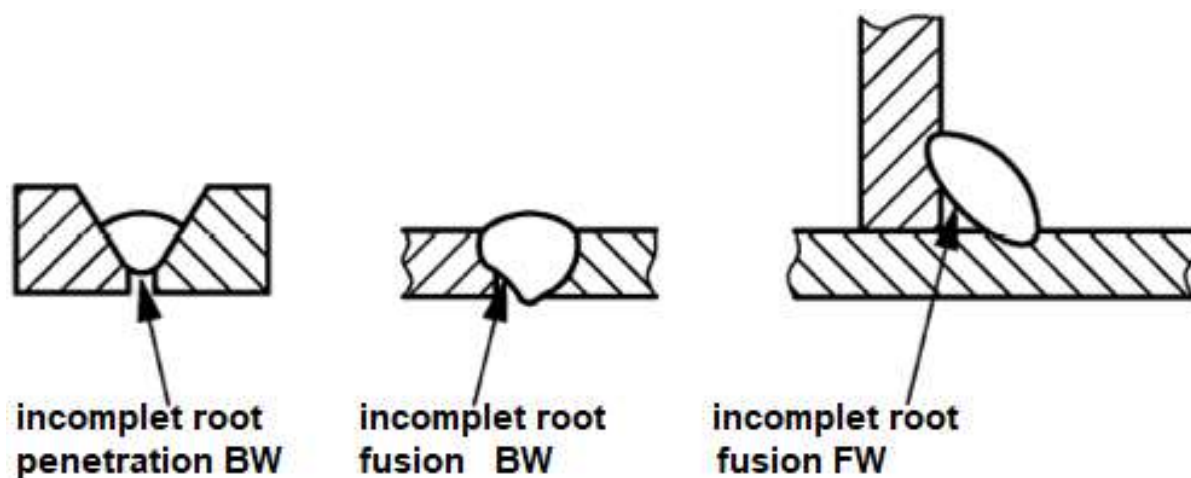

Porosity

- Porosity is caused by the absorption of nitrogen(N), oxygen(O) and hydrogen(H) in the molten weld pool which is then released on solidification to become trapped in the weld metal.

surface porosity

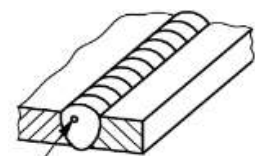

porosity

subsurface porosity

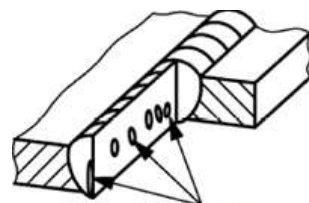

porosity

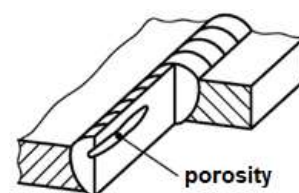

porosity

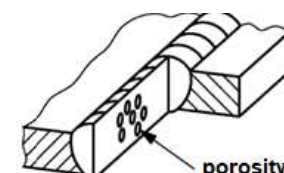

porosity

Slag inclusions

- Slag is normally seen as elongated lines either continuous or discontinuous along the length of the weld. This is readily identified in a radiograph.
- The slag becomes trapped in the weld when two adjacent weld beads are deposited with inadequate overlap and a void is formed. When the next layer is deposited, the entrapped slag is not melted out.



linear inclusions



isolated inclusions



clustered inclusions

Undercuts

- Undercutting is when the weld reduces the cross-sectional thickness of the base metal and which reduces the strength of the weld and workpieces.
- Reasons
 - excessive current
 - poor technique
 - using an incorrect filler metal

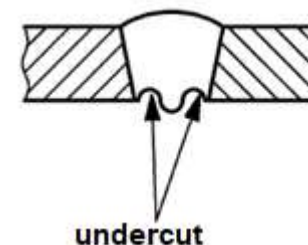
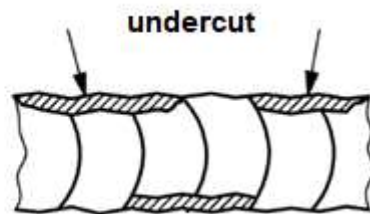
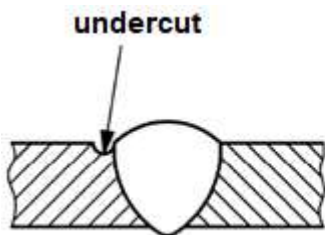

Spatters

- Weld spatter consists of droplets of molten metal or non-metallic material that are scattered or splashed during the welding process.
- Weld spatter is generally caused by the disturbance of the weld pool.
- Causes:
 - Long/short welding arc
 - Cleanliness of the parent material surface
 - Shielding gas (CO₂ welding yields more)
 - Wrong welding angle
 - Incorrect wire feed speed

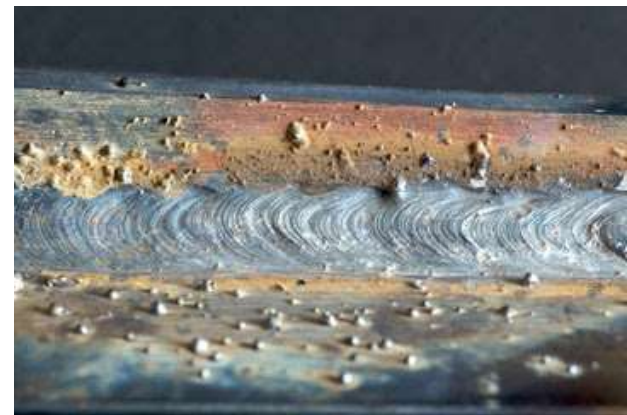

Useful Topic Related Links



(shielding gas) - https://en.wikipedia.org/wiki/Shielding_gas

(metal transfer) - <https://www.youtube.com/watch?v=8RjChhNa1k>

(metal transfer) - https://www.youtube.com/watch?v=w_znOqL8a98

(short -circuit) - <https://www.youtube.com/watch?v=s4iUzqLtYPQ>

(pulsed transfer) - <https://www.youtube.com/watch?v=rxqdtYJ71YQ>

(welding current) - <https://www.youtube.com/watch?v=aXYZfjZmE18>

EN ISO 6520-1:2007 Clasification of geometric imperfections in metallic materials - Part1: Fusion welding

II. Basics of fusion welding processes

II.5. Submerged Arc Welding



Aim & Objectives

Module Aim:	The module provides general information about Submerged Arc Welding (SAW)
Number of hours:	1 h for e-learning and 1 h for self-study
Learning Outcomes:	<ul style="list-style-type: none">• Learn about SAW principles• Identification of the application range and joint edge preparation• Knowledge of the selection criteria of flux-wire combinations
ECVET:	3 points

Lecture Outline

- SAW process principles
- Advantages
- Disadvantages
- SAW process variables

Submerged Arc Welding

SAW process principles

SAW process principles

- 1 – wire/strip electrode;
- 2 – wire/strip storage roll;
- 3 – wire/strip electrode feeding mechanism;
- 4 – wire/strip electrode straightening mechanism;
- 5 – contact tube;
- 6 – flux delivery tube;
- 7 – flux;
- 8 – power source;
- 9 – base material;
- 10 – electric arc;
- 11 – flux recovery tube;
- 12 – molten metal pool;
- 13 – slag layer;
- 14 – weld bead.

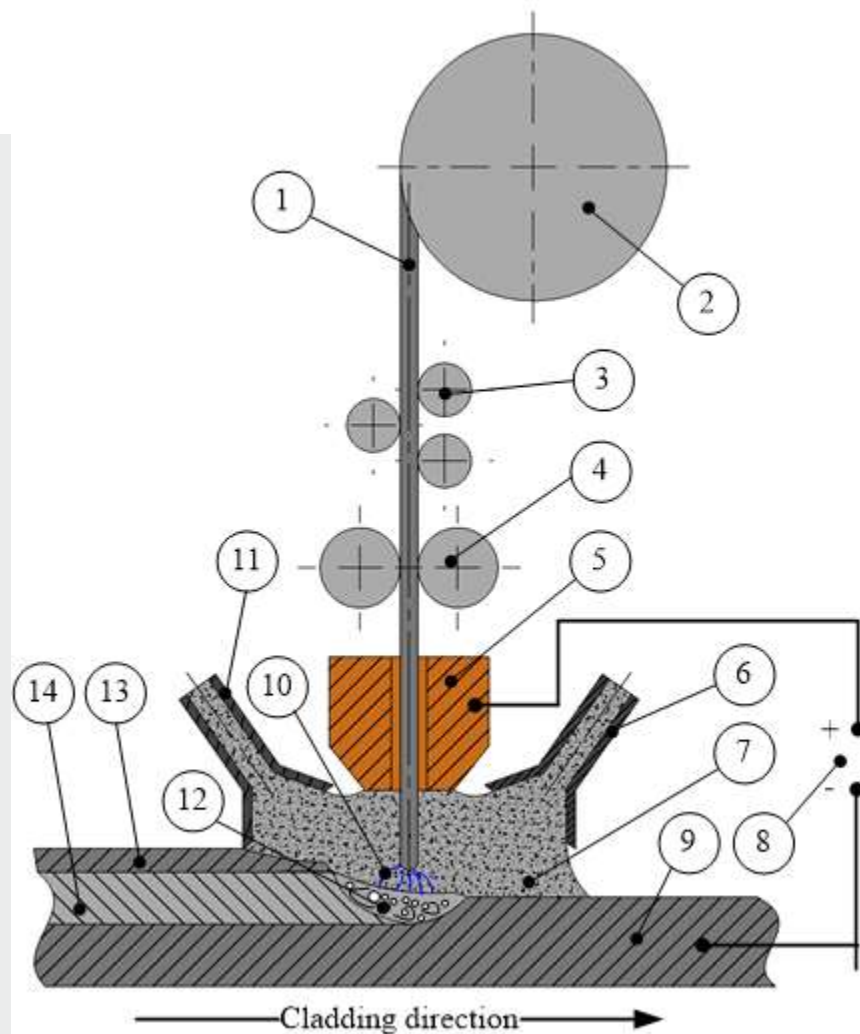

SAW process principles – cladding with strip electrode

- 1 – wire/strip electrode;
- 2 – wire/strip storage roll;
- 3 – wire/strip electrode feeding mechanism;
- 4 – wire/strip electrode straightening mechanism;
- 5 – contact skid/nozzle;
- 6 – flux delivery tube;
- 7 – strip storage roll;
- 8 – supplementary electrode strip;
- 9 – supplementary electrode strip feeding mechanism;
- 10 – flux;
- 11 – power source;
- 12 – base material;
- 13 – electric arc;
- 14 – molten metal pool;
- 15 – solid flux recovery;
- 16 – slag layer;
- 17 – cladded layer.

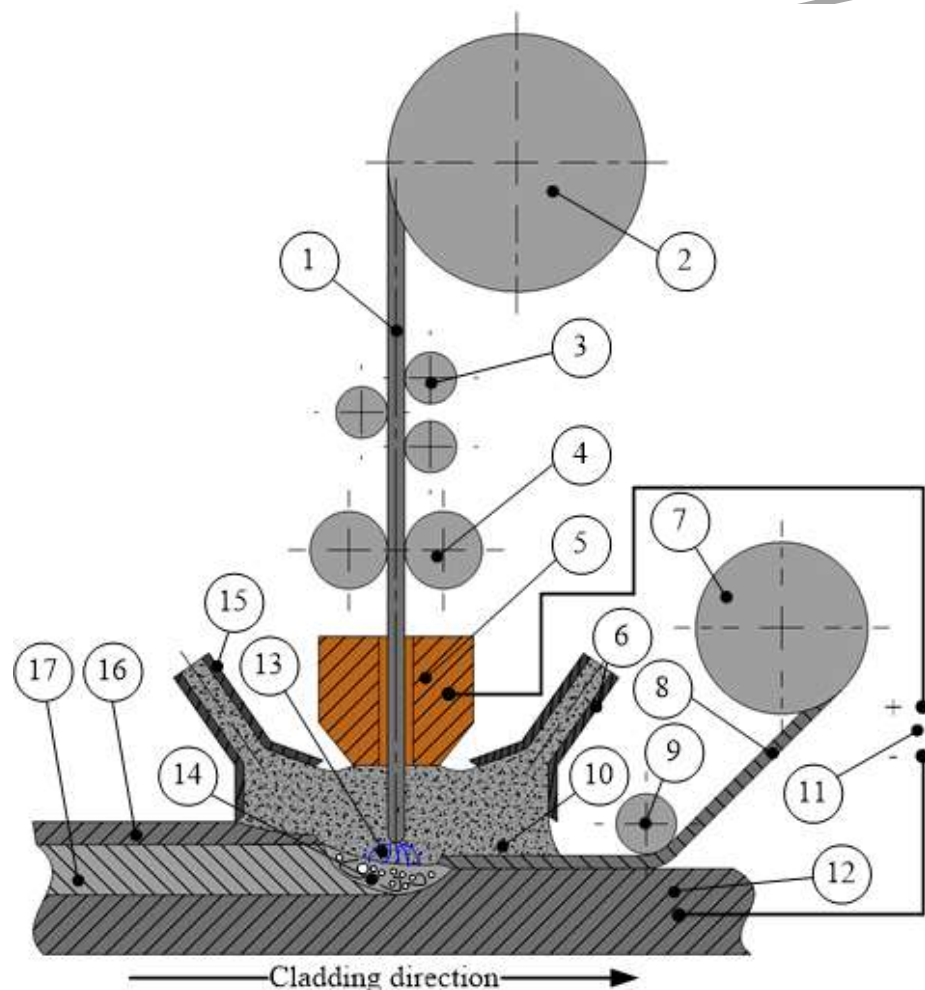

SAW process principles



www.ductil.ro



www.ductil.ro

Submerged Arc Welding

Advantages and disadvantages

2016-1-RO01-KA202-024508

The content of the present material is the sole responsibility of the authors, and the National Agency and European Commission cannot be held responsible for any use which may be made of the information contained therein.



Co-funded by the
Erasmus+ Programme
of the European Union

Advantages

- High deposition rates (over 45 kg/h have been reported)
- High operating factors in mechanized applications
- High weld penetration
- High speed welding of thin sheet steels up to 5 m/min is possible
- Minimal welding fume or arc light is emitted
- Single pass welds can be made in thick plates with standard equipment
- The arc is always covered under a blanket of flux, thus there is no chance of spatter of weld
- 50% to 90% of the flux is recoverable, recycled and reused

Disadvantages

- Limited to ferrous (steel or stainless steels) and some nickel-based alloys.
- Normally limited to the PA and PB positions.
- Normally limited to long straight seams or rotated pipes or vessels.
- Requires relatively troublesome flux handling systems.
- Flux and slag residue can present a health and safety concern.
- Requires inter-pass and post weld slag removal.
- Requires backing strips for proper root penetration.

SAW process variables

- Wire feed speed (main factor in welding current control – only when DC power source is applied)
- Welding current
- Arc voltage
- Travel speed
- Electrode stick-out (ESO) or contact tip to work (CTTW)
- Polarity and current type (AC or DC) and variable balance AC current

Material applications

- Carbon steels (structural and vessel construction)
- Low alloy steels
- Stainless steels
- Nickel-based alloys
- Surfacing applications (hardfacing, build-up, and corrosion resistant overlay of steels)

Submerged Arc Welding

Wire and flux

Wire

SAW is normally operated with a single wire on either AC or DC current. Common variants are:

- single wire
- twin wire
- multiple wire (tandem or triple)
- single wire with hot or cold wire addition
- metal powder addition
- fluxcored wire

Flux

Fluxes used in SAW are granular fusible minerals containing oxides of manganese, silicon, titanium, aluminium, calcium, zirconium, magnesium and other compounds such as calcium fluoride.

The flux is specially formulated to be compatible with a given electrode wire type so that the combination of flux and wire yields desired mechanical properties. All fluxes react with the weld pool and affect the weld metal chemical composition and mechanical properties. It is common practice to refer to fluxes as 'active' if they add manganese and silicon to the weld, the amount of manganese and silicon added is influenced by the arc voltage and the welding current level.

Flux

The main types of flux for SAW are:

- **Agglomerated fluxes** - produced by drying the ingredients, then bonding them with a low melting point compound such as a sodium silicate. Most bonded fluxes contain metallic deoxidisers which help to prevent weld porosity. These fluxes are effective over rust and mill scale.
- **Fused fluxes** - produced by mixing the ingredients, then melting them in an electric furnace to form a chemically homogeneous product, cooled and ground to the required particle size. Smooth stable arcs, with welding currents up to 2000 A and consistent weld metal properties, are the main attraction of these fluxes.

SAW welding equipment

Welding Boom



www.ductil.ro

Welding carriage



www.ductil.ro

SAW welding equipment



www.ductil.ro

2016-1-RO01-KA202-024508

The content of the present material is the sole responsibility of the authors, and the National Agency and European Commission cannot be held responsible for any use which may be made of the information contained therein.



Co-funded by the
Erasmus+ Programme
of the European Union

Useful Topic Related Links



[SAW 1](#)

[SAW 2](#)

[SAW 3](#)



[SAW 1](#)

[SAW 2](#)

[SAW 3](#)

II. Basics of fusion welding processes

II.6. Laser welding; Electron Beam welding; Plasma welding



Aim & Objectives

Module Aim:	The module provides general information about Laser welding; Electron Beam welding; Plasma welding
Number of hours:	1 h e-learning and 1 h self-study
Learning Outcomes:	<ul style="list-style-type: none">Principles description of the mentioned welding processes and their application
ECVET:	3 points

Lecture Outline

This lecture deals with presenting the theoretical aspects of:

- Laser welding;
- Electron beam welding
- Plasma arc welding

Laser welding

Principles description

2016-1-RO01-KA202-024508

The content of the present material is the sole responsibility of the authors, and the National Agency and European Commission cannot be held responsible for any use which may be made of the information contained therein.



Co-funded by the
Erasmus+ Programme
of the European Union

Laser welding principles description

LASER WELDING is a process where a high power light beam is used to transfer large amount of energy to a small spot on workpiece surface, in order to melt or vaporize the material being welded. There are two basic mechanisms by which laser welding can occur in metals: conduction welding and keyhole welding.

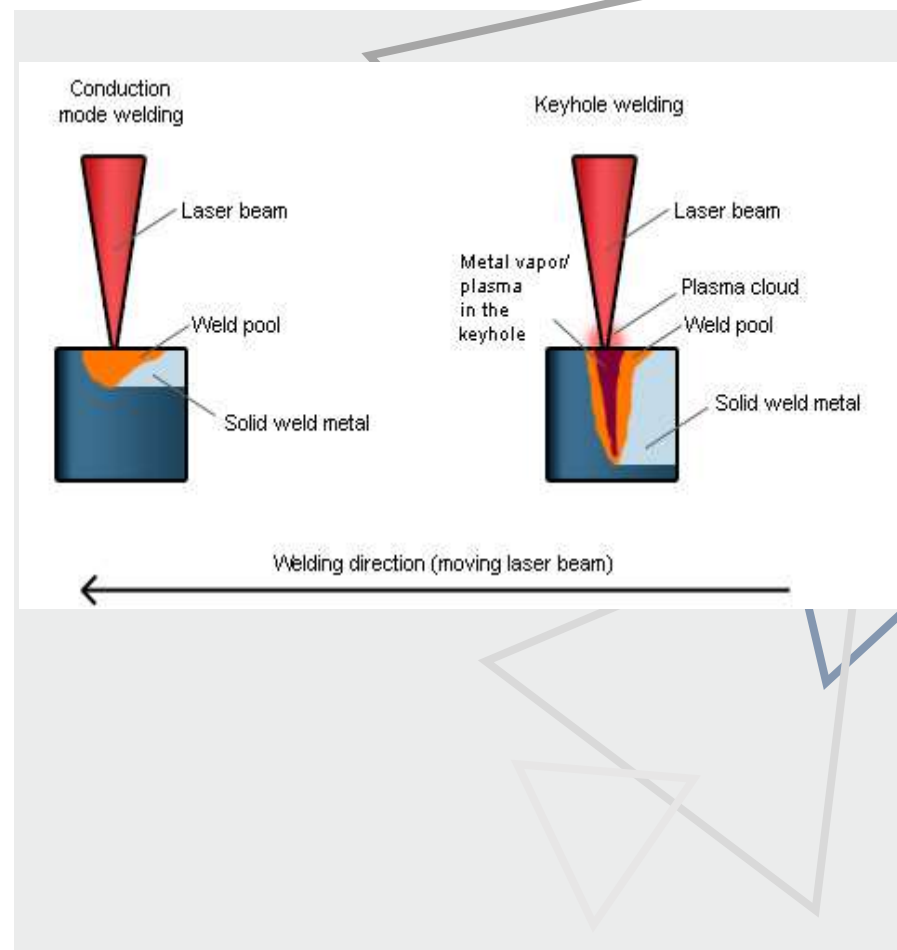

- **IN KEYHOLE LASER WELDING** the high-temperature vapor and plasma expands resulting in a recoil force that pushes on the surrounding molten material forming a narrow cavity, i.e. a keyhole, penetrating the molten material. When the laser beam moves over the workpiece, the metal along the leading edge of the keyhole is melted through its entire thickness. The liquid metal flows around the keyhole, and re-solidifies at the trailing edge. The molten pool surrounding the keyhole has characteristically a teardrop shape, and a temperature is considerably higher than that of a conventional arc weld. The weld geometry is characteristically deep and narrow.
- **IN CONDUCTION WELDING** the laser power density is not high enough to form a keyhole, and the heat is conducted into the material from the surface. As a consequence, the weld geometry is characteristically shallow and wide, and it resembles conventional arc welds.

Advantages

- Possibility to weld high alloy metals without difficulty
- Can be transmitted over long distances with a minimal loss of power
- Narrow heat affected zone
- Low total thermal input
- Welds dissimilar metals
- No filler metals necessary
- Produces deep and narrow welds
- Low distortion in welds
- High quality welds

Disadvantages

- Rapid cooling rate may cause cracking in some metals
- High capital cost for equipment
- Optical surfaces of the laser are easily damaged
- High maintenance costs

Electron beam welding

Principles description

2016-1-RO01-KA202-024508

The content of the present material is the sole responsibility of the authors, and the National Agency and European Commission cannot be held responsible for any use which may be made of the information contained therein.



Co-funded by the
Erasmus+ Programme
of the European Union

Electron beam welding principles

The electron beam welding equipment

- 1 – cathode;
- 2 – voltage control;
- 3 – electron beam;
- 4 – anode
- 5 – focus coils (magnetic lens);
- 6 – deflection coils;
- 7 – optical system;
- 8 – electron gun;
- 9 – working chamber;
- 10 – positioning mechanism;
- 11 – weld bead;
- 12 – welding carriage.

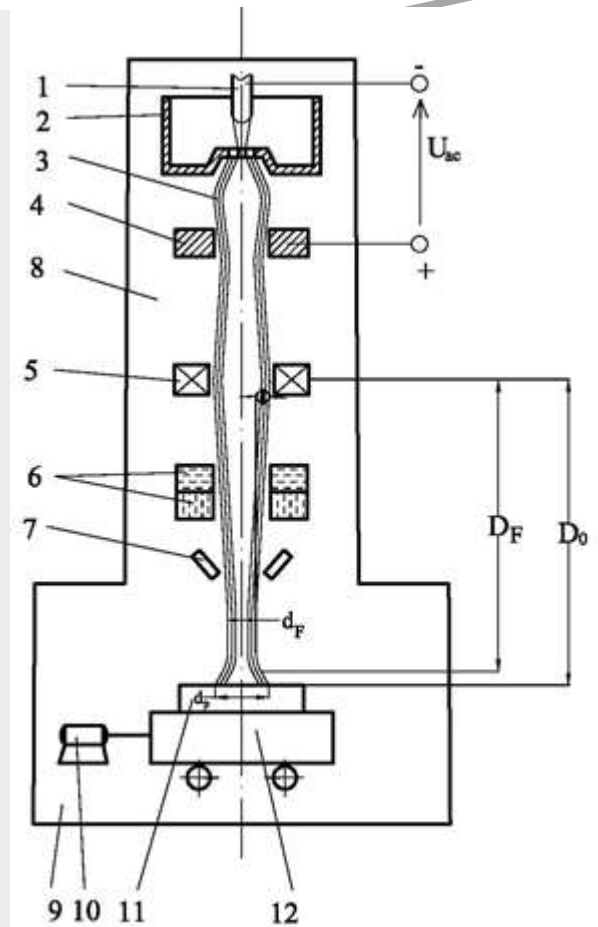

Advantages

- No gas contamination (vacuum environment).
- Deepest weld penetration (controlled by controlling the accelerating voltage, beam current and beam focus).
- Small heat affected zone.
- It allows welding of titanium, refractory metals and flammable metals.
- Filler metal or flux are not needed to be used in this process of welding.
- The process can be used at higher welding speeds, typically between 125 to 200 mm/s.

Disadvantages

- Due to vacuum enclosure high initial set up cost.
- Size is restricted by vacuum chamber. Only small to medium size components can be welded.
- X-rays generated during welding.
- Longer cycle time than laser beam welding so this process is time consuming.

Plasma arc welding

Principles description

2016-1-RO01-KA202-024508

The content of the present material is the sole responsibility of the authors, and the National Agency and European Commission cannot be held responsible for any use which may be made of the information contained therein.



Co-funded by the
Erasmus+ Programme
of the European Union

Plasma arc welding principles

- 1 – tungsten electrode
- 2 – constricting nozzle
- 3 – electric arc
- 4 – shielding gas nozzle
- 5 – filler wire
- 6 – filler wire feeding
- 7 – contact tube
- 8 – molten metal drops
- 9 – base material
- 10 – clad layer
- 11 – power supply
- 12 – filler wire heating power source

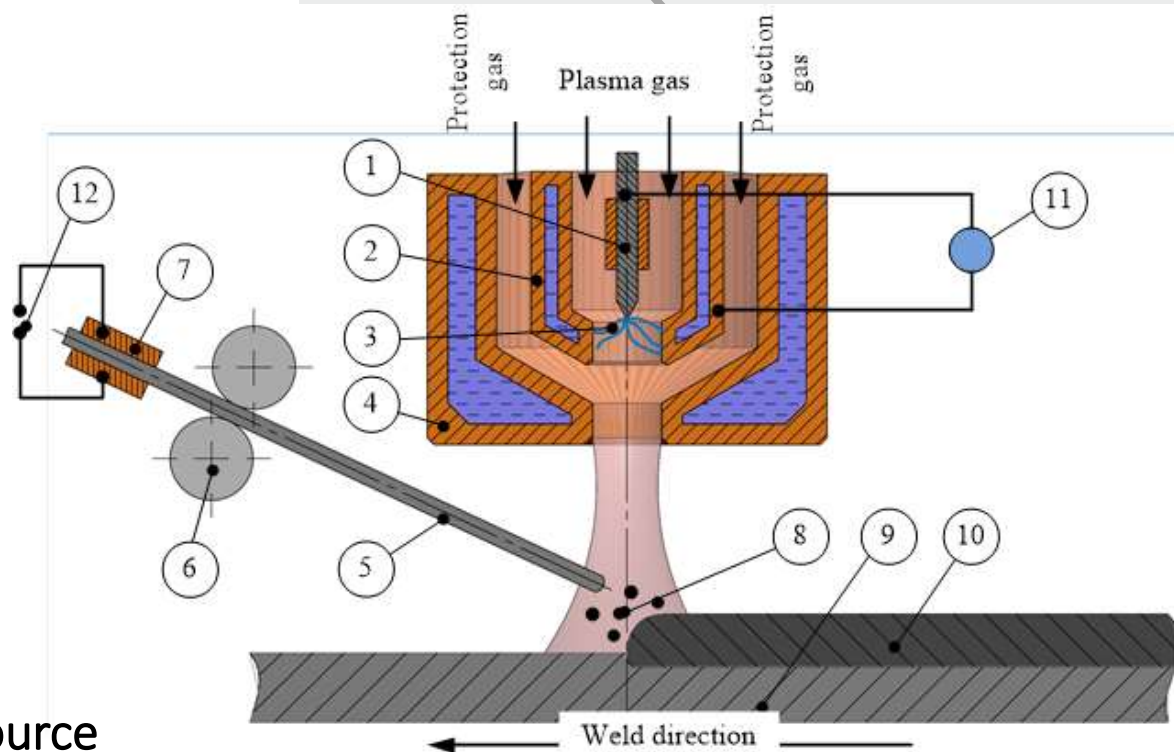

Advantages

- Keyhole effect (complete single pass penetration)
- Faster travel speed

Disadvantages

- Replacement of the plasma nozzle is frequently necessary
- Expensive equipment
- More skill needed than for GTAW process

Useful Topic Related Links



[Laser welding](#)

[Electron beam welding](#)

[Plasma arc welding](#)



[Laser welding](#)

[Electron beam welding](#)

[Plasma arc welding](#)